

# NEWS CAPSULES

### Aid Bill Advances

WASHINGTON (UPI) — The \$227 million and authority to use American troops in evacuation operations in South Vietnam requested by President Ford 18 days ago, appeared headed for congressional approval today. The House votes this afternoon on a House-Senate conference report and if it passes it will be sent to the White House where the President is expected to sign it. Ford is waiting for Congress to tell him what power he has to evacuate allied Vietnamese, who might face Communist reprisals.

### Protter Surrenders

JOHANNESBURG (UPI) — David Protter, a South African Jew employed by the Israeli Consulate as a security officer, surrendered to police today. Protter Monday took over the consulate single-handedly and held the more than 20 persons in the building hostage for 16 hours. At least two persons were killed and 32 injured, although none of the hostages was harmed. Protter threatened to blow up the building, along with the hostages, unless he was given safe passage to Tel Aviv in an Israeli plane where he apparently wanted to speak with the prime minister. Protter surrendered quietly just before dawn and was driven to Pretoria by South African police.

### Wallace Queried

WASHINGTON (UPI) — George C. Wallace ran into a hornet's nest of questioning House freshmen Democrats Monday. He had come to Capitol Hill to testify in support of federal tax checks that state officials will mail in the questioning, Wallace was given a temporary respite by the buzzer signaling a House vote, but he was asked to wait and resume the discussion after the vote was taken. Finally the ordeal was over and a tired Wallace was wheeled from the room with his wife by his side.

### Chrysler Seeks Sales

DETROIT (UPI) — The Chrysler Corp. is launching a new rebate program to persuade car buyers to buy its small cars. And it's tying its promise of \$200 rebates to the federal tax rebate checks that state officials will mail in the questioning, Wallace was given a temporary respite by the buzzer signaling a House vote, but he was asked to wait and resume the discussion after the vote was taken. Finally the ordeal was over and a tired Wallace was wheeled from the room with his wife by his side.

### Air Fares Go Up

WASHINGTON (UPI) — Fares for short domestic airline coach flights rose today, but those for long-distance coach flights dropped under new rate schedules ordered by the Civil Aeronautics Board.

### O'Neill Picked

HARTFORD (UPI) — William A. O'Neill, taking the reins of the Democratic party in Connecticut, is determined to be his own man.

### Bomb Injures Six

DENVER (UPI) — Bombs exploded in front of the home of a Central Intelligence Agency official and in the streets of a downtown bank Monday, injuring six persons. Police said today they did not know if the explosions were the work of terrorists or "just some crackpot."

### Newman Cursed

WASHINGTON (UPI) — Former CIA Director Richard Helms cursed a newsmen and denied the Central Intelligence Agency was involved in the assassination of foreign officials.

### Search Resumed

AUGUSTA, Maine (UPI) — A massive sea and air search was resumed today for seven persons aboard a missing single-engine plane that vanished on a flight from Massachusetts to New Brunswick Sunday night.

### Civil Rights Meet

BOSTON (UPI) — The Massachusetts Advisory Committee to the U.S. Commission on Civil Rights will meet May 6 in Boston.

### Sex Bias Denied

MIDDLETOWN (UPI) — A Connecticut feminist leader says birth control advocate Bill Baird was never invited to debate at a conference Sunday, when he said he was barred from speaking because of his sex.

## School-Rec Project Backed

By JUNE TOMPKINS  
The Board of Education Monday night approved in concept proposed additions and renovations to Bentley School and the proposed joint venture with the Town Recreation Department for additions and renovations to Washington School.

## POLICE REPORT

**MANCHESTER**  
• Russell E. Labonte, 27, of 87 Spruce St. was arrested Monday at 12:35 p.m. on Charter Oak St. and charged with disorderly conduct, riding his bicycle on the sidewalk, failure to ride on the right side of the road, and failure to obey officer's signal, police said.

## GOP Women Will Elect

The Republican Women's Club will have its annual meeting and election of officers May 7 at the Manchester Country Club.

## Flea Market Aids New Hope Manor

A flea market will be conducted Saturday and Sunday at the New Hope Manor, 485-227, in Middletown for the benefit of New Hope Manor, Connecticut's only drug and rehabilitation center for teenage girls.

## Civil Rights Meet

The Massachusetts Advisory Committee to the U.S. Commission on Civil Rights will meet May 6 in Boston.

## Mayor, Manager Agree To Curtail Spending

Mayor John Thompson said Monday he has assurances from the town manager all efforts will be made to curtail public spending between now and June 30, the end of the current fiscal year.

## Resigns

Ronald H. Roberts of Tolland Monday resigned from the Manchester Police Department, Chief Robert Lannan announced.

## Spring is Here

**The Coventry Shoppo**  
DEPOT ROAD COVENTRY  
DRESSES ..... \$8.98 to \$29.95  
PANT SUITS ..... \$16.98 to \$34.95  
GOWN ..... \$18.98 to \$29.95 Casual  
Mother of Bride & Groom ..... \$22.95 to \$49.95

## SPORTSWEAR IN ALL SIZES ALSO

**WIDE ASSORTMENT**  
SWIM SUITS ..... \$10.98 to \$24.95  
SHORTS ..... \$4.98 to \$6.98  
Children's Wear also Trim Girl & Teen

## AGWAY Inc.

**Dunlop's Steel Radials.**  
The 40,000 mile gas (Energy) savers.

**DUNLOP SP4 BELTED STEEL RADIALS!**  
\$37.95 plus F.E.T. Size 16JR-14 reg. \$41.95

**DUNLOP ELITE STEEL RADIAL!**  
The 40,000 mile tread wear policy\* is a bonus for you!  
\$53.95 plus \$2.99 F.E.T. Size GRT-8 reg. \$56.95

**OTHER SIZES ON SPECIAL PRICES ALSO**

**IF NOT IN STOCK WE'LL ORDER AT SALE PRICE FOR YOU**

**FREE MOUNTING! NO TRADE-IN REQUIRED!**

**AGWAY Inc.**  
540 NEW STATE ROAD, BUCKLAND  
643-5123

## Triumphant Reds Take Over Saigon

MANCHESTER, CONN., WEDNESDAY, APRIL 30, 1975 — VOL. XCIV, No. 179

## Vietnamese War Refugees Begin Arriving

By WALTER WISNEWSKI  
United Press International  
The first wave of the survivors of Saigon rescued by the U.S. airlift has arrived in the United States, and hundreds of the Vietnam refugees got out today to find new homes and new lives in America.

Some Americans criticized the migration of Vietnamese to this country. But other U.S. citizens asked for understanding and a welcoming attitude for the exiles.

## Waiting for a Tent

A Vietnamese mother feeds her young child on a sheet of cardboard in the Tent City at the Agana, Guam, Naval Station while awaiting assignment to a tent.

## Local Vietnam Veterans Bitter Over Saigon's Capitulation

By BETTY RYDER  
Area veterans of the Vietnam expressed mixed emotions over the surrender of South Vietnam to the North Vietnamese Communists yesterday and said it was a war of waste.

## Capitol Hill Reaction Muted and Guarded

WASHINGTON (UPI) — The abrupt end of American involvement in the Vietnam War after more than a decade of impassioned congressional debate was greeted today with a muted response on Capitol Hill and the rest of official Washington.

## New England Marine One of Last to Die

By United Press International  
Charles McMahon Jr., 22, named "Boy of the Year" in Woburn, Mass., in 1971, was at home earlier this month, relaxing with his friends.

# Manchester Evening Herald

Manchester—A City of Village Charm TWENTY-EIGHT PAGES — TWO SECTIONS PRICE: FIFTEEN CENTS

## Unconditional Surrender Ends 35 Years of War

SAIGON (UPI) — A triumphant Communist army riding tanks, trucks and captured American Jeeps took over Saigon today and raised the Viet Cong flag over the presidential palace in what the Communist world hailed as a great victory of historic importance.

The Viet Cong and North Vietnamese troops jubilant over the unconditional surrender that ended 35 years of war against American, French, Japanese and South Vietnamese forces—sized Saigon radio and announced they were renouncing the South Vietnamese capital "Ho Chi Minh City."

## Local Vietnam Veterans Bitter Over Saigon's Capitulation

Area veterans of the Vietnam expressed mixed emotions over the surrender of South Vietnam to the North Vietnamese Communists yesterday and said it was a war of waste.

## Capitol Hill Reaction Muted and Guarded

WASHINGTON (UPI) — The abrupt end of American involvement in the Vietnam War after more than a decade of impassioned congressional debate was greeted today with a muted response on Capitol Hill and the rest of official Washington.

## New England Marine One of Last to Die

By United Press International  
Charles McMahon Jr., 22, named "Boy of the Year" in Woburn, Mass., in 1971, was at home earlier this month, relaxing with his friends.

## War Ends for United States With No Rallies, Parades

WASHINGTON (UPI) — The Indochina War ended as one American conflict had: with U.S. citizens and their friends evacuated by helicopter, with gun-toting Marines to protect them from both the enemy and the former allies they left behind.

## Inside Today

Senior Citizens	Page 3
Hi Neighbor	Page 4
Community Spirit of '75	Page 5
On Second Thought	Page 10
Dear Abby	Page 16
Scene from Here	Page 18
Sturd Investiture	Page 18
Stamps and coins	Page 28
Girl golfer makes history	Page 15
East side qualifies	Page 16
10 in row for East golfs	Page 15
Racquet club champs	Page 17
Indian truckmen win	Page 17
Area Profile	Pages 6, 8, 9, 11, 20

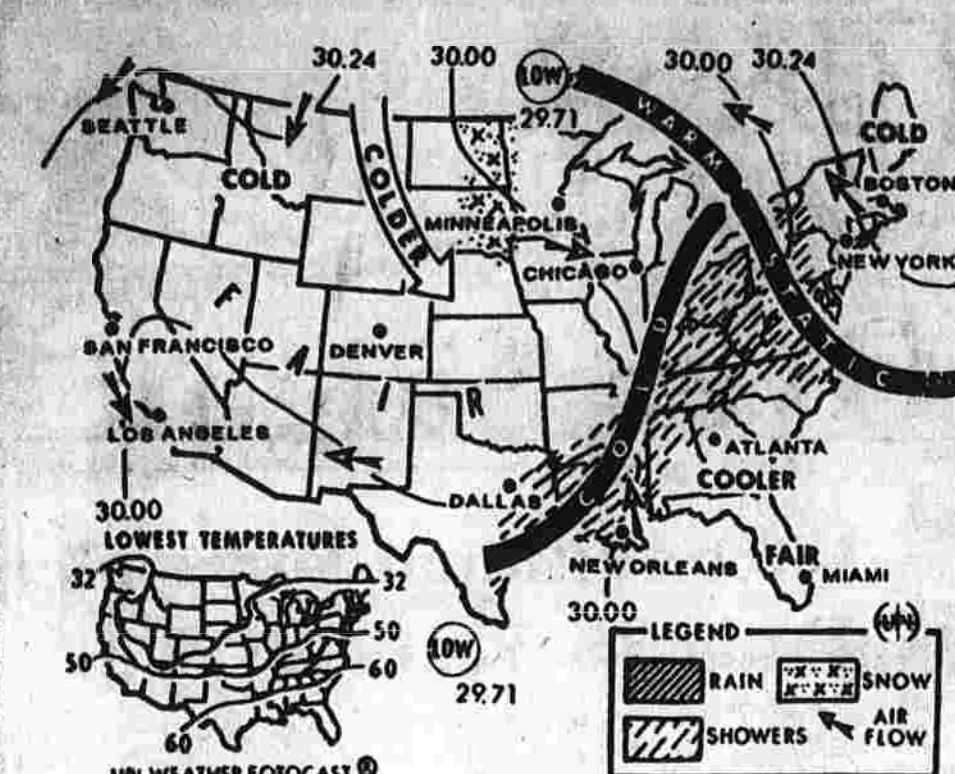

For Period Ending 7 AM EST Thursday, Wednesday night will find snow activity in eastern North and South Dakota, while showers and or rain will be indicated from eastern Texas, northeastward through the Tennessee valley, the Ohio valley, the mid Atlantic states and the lower Lakes area.

Film Rating Guide for Parents and Their Children. Includes categories: G (General Audiences), PG (Parental Guidance), R (Restricted), and X (No One Under 17 Admitted).

MANCHESTER HOSPITAL NOTES. Discharged Monday: John Spencer, 66 Holl St.; Donald Villeneuve, 78 North St.; Vernon, Florence Johnson, 96 Starkweather St.; Lawrence Bunce, 66 Devon Dr.; Marie Pellerin, 333 Bidwell St.; Joan Charas, 175 Tudor Lane; Julie Conran, East Hartford; Rosemary Viets, 7 Talcott Ave.; Rockville, Carol Olson, 265 Amia Dr.; Susan Bidwell, 113 Deepwood Dr.; Susan Bidwell, 113 Deepwood Dr.

White Lightning. Burt Reynolds (PG). Eyes 7:10-9:10. SAT. MAY 2, 7:10-9:10. SUN. CONT. 2 PM.

ABOUT TOWN. Senior High Youth Forum of North United Methodist Church will meet Thursday at 7 p.m. at the church.

BURNSIDE 1 & 2. CINE 1: BEN GAZZARA JOHN CASSAVETES. CINE 2: ALICE DOESN'T LIVE HERE ANYMORE.

THEATRES EAST. 1: "SHAMPOO". 2: "THE YAKUZA". 3: "BLAZING SADDLES".

SHOWCASE CINEMAS 1234. CINE 1: THE REINCARNATION OF PETER PRUD. CINE 2: TOMMY.

Funny Lady. STREISAND & CAAN. ESCAPE TO WITCH MOUNTAIN.

Funny Lady. STREISAND & CAAN. ESCAPE TO WITCH MOUNTAIN.

Funny Lady. STREISAND & CAAN. ESCAPE TO WITCH MOUNTAIN.

TV TONIGHT. 6:00 News, 6:30 The Untouchables, 7:00 The Champions, 7:30 The Homecoming, 8:00 Electric Company, 8:30 Bonanza, 9:00 News, 9:30 Teacher Previews, 10:00 Music Project, 10:30 Cannon, 11:00 Pat Boone Special, 11:30 Movie, 12:00 Theater in America, 12:30 The Best of Groucho, 1:00 I Love Lucy, 1:30 Captained News, 2:00 Dan August, 2:30 News, 3:00 Movies, 3:30 Liz Taylor Profile, 4:00 Garner Ted Armstrong, 4:30 Johnny Carson, 5:00 Movie, 5:30 Greatest Sports Legends, 6:00 Music Project, 6:30 Tomorrow, 7:00 News, 7:30-8:00 Reel Camp.

COUNTRY LOFT. HEIRLOOMS OF TOMORROW ARE AT COUNTRY LOFT. 254 BROAD ST. MANCHESTER. Merchants in Early American Furniture Reproductions and Nautical Paraphernalia. OPEN TUES., WED., SAT. 10 A.M. - 5:30 P.M. SUNDAY 12 NOON - 5 P.M. THURS. & FRI. 10 A.M. - 9 P.M.

DRY SINKS. Light or Dark Pine. \$74.95 to \$129.99. Reg. 99¢ - 199¢.

Hartford Civic Center. Tue. May 6 thru Sun. May 11. RINGLING AND BARNUM BROS. CIRCUS. NEW! SEE THE MOST AMAZING MIXED WILD ANIMAL ACT EVER DARED!

Authentic Pot Belly Stoves. CAST IRON • FINISHED BLACK. 28" High x 15" Dia. \$129.99. Reg. \$149.99.

CHECK LIST OF OTHER GIFTS FOR MOTHER: LAMPS, ROCKERS, MIRRORS, SCONCES, END TABLES, SHELVES, FIREPLACE FURNISHINGS, DINING ROOM SETS, LIVING ROOM SETS.

East Hartford Lions Club CARNIVAL. April 29 through May 4 at the Topp's Shopping Plaza. 30 SPECTACULAR RIDES. CHILDREN'S DAY Saturday, May 3 12-8 p.m. ALL NEW IN '75.

Coleman Bros. Shows. "New England's Largest Traveling Show". DELUXE BURGER 89¢, CHICKEN DINNER 89¢, D.Q. HOME PAK 99¢, BIG 1/2 LB. SUPER CHEESEBURGER \$1.39.

NEWS FOR SENIOR CITIZENS. By WALLY FORTIN. The big news here is about our Connecticut River Cruise on May 14. We held registration Monday, and I was very surprised at the small turnout, especially after the wonderful ride down the river last year.

Big Week. We're having a fancy Chinese dinner prepared and served by our top cook Frank Latocca, and students from the Manchester Community College. We're happy to announce that the tickets have been sold.

Study Indicates American Dream May Be Fading. PATRICIA McCORMACK. NEW YORK (UPI)—Thirty-seven per cent of America's families, a new study shows, may be losing faith in the American dream.

Grant City. SALE ENDS SATURDAY MAY 3rd. PRICE CUT! 2 for \$3 GRANTS BROOMS and MOPS. 2 \$1 9oz. & 10 oz. Bags CIRCUS PEANUT CANDIES.

Grant City. Pampers. BOX OF 30 Daytime PAMPERS \$1.88. LIMIT: 2 Boxes white 200 per Store Lasts.

Grant City. SHOP-AT-HOME SPECIAL! SAVE 25%. ASSORTMENT OF ELEGANT CUSTOM DRAPERY FABRICS.

Grant City. WOMEN'S NYLON PANTYHOSE OR KNEE HI'S 4 \$1. LIMIT: 2 Pkg. per Customer.

Grant City. KNOWN FOR VALUES. NEWINGTON, MIDDLETOWN, WINDSOR, MANCHESTER, AVON, BARNHARTMAN, FARMINGTON VALLEY, BRISTOL, HARTFORD, WETHERFIELD, 121 Farmington Ave., 240 Hartford Ave., 560 Windsor Ave., 600 Barnhartman Ave., 48 Elm Street, 185 State Street, 200 North Main Ave.

Grant City GRAND OPENING. NOW THRU SATURDAY MAY 3. ALL STORES CELEBRATE THE OPENING OF OUR NEW WATERTOWN, CONN. STORE.

4-Pc. Redwood Group with Foam Cushions. \$77 Set Regular \$88. RUSTIC CALIFORNIA REDWOOD FRAMES WITH DOUBLE SPRINGS AND STEEL STRAP SUPPORTS.

Multi-Position Lounger. \$12. Regular \$14.97. Pick your favorite position and enjoy relaxing comfort... it even folds flat for compact storage!

Bradford 12" DIAG. MEAS. PORTABLE TELEVISION. \$57. Personal size portable that's ideal for den, kitchen, bedrooms — and an especially bright buy for children's rooms.

Grant City. SALE ENDS SATURDAY MAY 3rd. PRICE CUT! 2 for \$3 GRANTS BROOMS and MOPS. 2 \$1 9oz. & 10 oz. Bags CIRCUS PEANUT CANDIES.

Grant City. Pampers. BOX OF 30 Daytime PAMPERS \$1.88. LIMIT: 2 Boxes white 200 per Store Lasts.

Grant City. SHOP-AT-HOME SPECIAL! SAVE 25%. ASSORTMENT OF ELEGANT CUSTOM DRAPERY FABRICS.

Grant City. WOMEN'S NYLON PANTYHOSE OR KNEE HI'S 4 \$1. LIMIT: 2 Pkg. per Customer.

3 APR 30



# Mayors Want State Funds For Obligatory Programs

**VERNON**  
 In a message released Monday, Vernon Mayor Frank McCoy, president of the Connecticut Conference of Mayors and Municipalities, urged state legislators and state officials to reject any proposed legislation which mandates programs unless accompanied by a 100 per cent reimbursement of the cost.

McCoy said state-mandated municipal services are identified and analyzed in a detailed report issued to all state legislators by the conference. He said the report covers 22 areas where state legislative mandates impose additional costs or administrative burdens on cities and towns.

He added that in some cases the state has failed to keep abreast of actual costs when

determining reimbursement rates, but in many cases there is no reimbursement at all. He said no such list has been compiled by the state so legislators have been awaiting its publication by the conference.

He listed some of the areas where the conference feels the state should either pay more of the bill or eliminate the mandate.

One of these areas is school transportation where he said the \$20 per pupil reimbursement only applies to students up to 14 years of age.

He said the increasing scope of mandates concerning water pollution control has not been met by money. He said there is only partial reimbursement for construction of sewage treatment plants and none at all for operating costs. Vernon is one of the towns that has been ordered to build a new treatment plant to abate pollution of the Hockanum River.

He said the state requires unemployment compensation for municipal employees but provides no funds, leaving the burden with the municipalities.

On the mandate concerning the phasing out of tax on merchants' inventories, there

is only partial reimbursement from the 1974-75 state reimbursement.

McCoy said.

There is a long list of other such programs, including the requirement of a municipal agent for elderly which the state doesn't finance but "passes the buck to local taxpayers," McCoy said.

Another area he mentioned was welfare which the towns must provide, but the state gives them nothing to administer such programs and reimburses only 90 per cent of the welfare grants.

He said the increasing scope of mandates concerning water pollution control has not been met by money. He said there is only partial reimbursement for construction of sewage treatment plants and none at all for operating costs. Vernon is one of the towns that has been ordered to build a new treatment plant to abate pollution of the Hockanum River.

He said the state requires unemployment compensation for municipal employees but provides no funds, leaving the burden with the municipalities.

On the mandate concerning the phasing out of tax on merchants' inventories, there

## The Herald

Area Profile

# CAR WASH AND WAX

with fill up of gas and 75¢



315 CENTER ST., MANCHESTER, CONN. Phone 643-3123

### Cardio-Pulmonary Training

**HEBRON**  
 Anne Dallaire  
 A training session in Cardio-Pulmonary Association will be held Monday, May 12 at the Gilead Hill Elementary School.

The session, to be conducted by the Hebron Junior Women's Club will run for four hours and will be limited to 50 residents.

All residents are invited to inquire about the session. For information contact Mrs. Carol Cobit of Jan. Dr. or Mrs. Jan Presti of Hope Valley Rd.

1 In 8 Women A Widow  
 Washington - About one in eight American women 14 or older is a widow; about one in 38 men 14 or older is a widower.

# Summer Opening Scheduled For School Libraries

**SOUTH WINDSOR**  
 South Windsor school libraries will be open either one-half or one full day per week during the school summer vacation.

The school department has agreed to set up "open days" following a request by School Supt. Robert Goldman.

Students may use the library to read or to take out books.

Since last year both school and town officials have been working on a program which would allow for more community use of buildings.

If the library program for the summer months proves successful it will be another step toward the community school concept for South Windsor.

Dr. Goldman said it is also possible that some schools may have volunteers who will conduct story hours for children during the summer.

If this program is successful it may serve as a model for the opening of schools in other ways during the summer months.

# SAVE MONEY WITH A QUALITY PAINT



**COVERS MORE... LOOKS BETTER... LASTS LONGER!**

That's right! Quality Dutch Boy House Paint actually saves you money. It covers more surface area because it has superior hiding power. It looks better, too! It's tough, brilliant finish wears slowly and evenly. Resists cracking and peeling. Keeps costly maintenance way down. So get the most for your money! Get quality Get Dutch Boy House Paint!

**more years to the gallon**

**E. A. JOHNSON PAINT CO.**  
 723 MAIN STREET MANCHESTER

## Anderson-Little

Before you pay more... compare!  
 Only at Anderson-Little... and only because we make our own... can you get such high quality at our direct-to-you low prices.

# Fashion-Light Suits

Our regular \$80 **59.95**  
*This week only!*

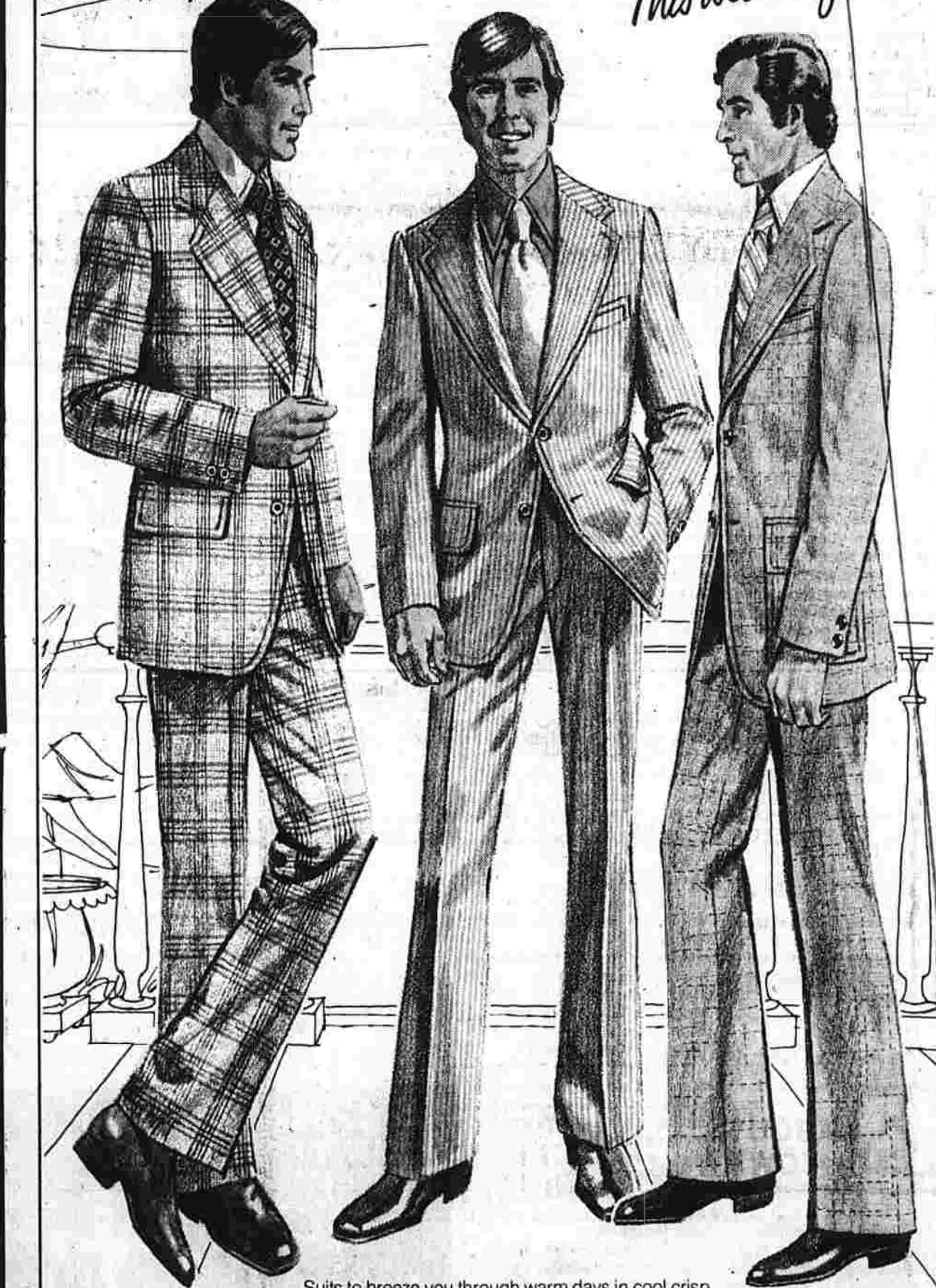

Suits to breeze you through warm days in cool crisp fashion. Fabrics specially chosen because they're light and comfortable, yet keep their shape! Cool linen looks. Surface textures. Light colors and pastels in solids, checks and plaids. Fashion pocket treatments and other fine details. Custom-tailoring quality at our own direct-to-you prices.

Unlike others, our policy is still complete expert alterations at no charge. What might cost you as much as \$15 elsewhere is free at Anderson-Little.

## Anderson-Little

A Great Name in the Manufacturing of Fine Clothing  
 • MANCHESTER Manchester Parkade

# McCarthy '76: To the Barricades Softly

By ARNOLD B. SAWISLAK  
 WASHINGTON (UPI) — Dodge the subway construction, litter on Connecticut Avenue, find the unmarked door between the Sewing Shoppe and the Soup-Er Cafeteria and ride the ancient elevator three floors to the hushed, nearly empty suite of offices.

There it is, McCarthy '76. The campaign headquarters of the politician-poet from Minnesota who began the job of dumping President Lyndon B. Johnson seven years ago and now has undertaken to seize the White House without benefit of a political party.

He is the same Eugene McCarthy, a tough grayer and a bit more baggy-eyed at age 59 but still displaying that odd mix of languid assurance and suppressed outrage that made him a hero on college campuses and in liberal saloons of the late 1960s.

He no longer is the organization Democrat who huzzaged for the vice presidency in 1964 and then sought to lead his party against its own President in 1968. Today he is a political loner, sitting in a rented office bare of the trappings of the past.

He speaks quietly now of leading a guerrilla campaign against the two-party system's grip on selection of U.S. government leaders.

McCarthy is the presidential candidate of the Committee for a Constitutional Presidency, which his friends created last summer. He calls it a "movement" rather than a political party.

He appears weekly before student forums, citizen groups and living room receptions where the faithful still revel in McCarthy's style — the wry digs at orthodox politicians, acid-dipped observations on the follies of government, the cool confidence in the rectitude of his views.

McCarthy does have a plan for 1976 to get his name on the presidential ballot in every state and then "confront" the two major party candidates.

His purpose, he says, is two-

fold — to challenge state laws that often require candidates to have the support of a conventional political party, and sometimes freeze out all but Democrats and Republicans.

"To force other candidates to discuss the present political process, which he believes has distorted the intentions of the Founding Fathers, and how they would conduct the office and use the power they are seeking."

McCarthy questions the methods both Democrats and Republicans use to select presidential candidates. He objects to campaign finance laws that limit individual contributions and favor the established parties in distorting public campaign funds.

"The question of procedure and how you operate, especially the presidency, in my mind is almost as important as where you may stand on the critical issues that face the country," McCarthy says.

"They ought to say who they would appoint attorney general and Treasury secretary... and perhaps even who they would appoint to the Supreme Court if they had the opportunity during their terms," he said in a recent interview.

The names, he suggested, would be a tipoff to voters about where a candidate stands. His own choices, he said, would reflect his concern over personal liberties and an economy which not only nurtures jobs and business but takes into account energy needs, conserving resources and protecting the environment.

—To challenge state laws that often require candidates to have the support of a conventional political party, and sometimes freeze out all but Democrats and Republicans.

"To force other candidates to discuss the present political process, which he believes has distorted the intentions of the Founding Fathers, and how they would conduct the office and use the power they are seeking."

McCarthy questions the methods both Democrats and Republicans use to select presidential candidates. He objects to campaign finance laws that limit individual contributions and favor the established parties in distorting public campaign funds.

"The question of procedure and how you operate, especially the presidency, in my mind is almost as important as where you may stand on the critical issues that face the country," McCarthy says.

"They ought to say who they would appoint attorney general and Treasury secretary... and perhaps even who they would appoint to the Supreme Court if they had the opportunity during their terms," he said in a recent interview.

The names, he suggested, would be a tipoff to voters about where a candidate stands. His own choices, he said, would reflect his concern over personal liberties and an economy which not only nurtures jobs and business but takes into account energy needs, conserving resources and protecting the environment.

## the Mother's Ring

Wear it with pride... cherish it always. The two bands of 14 karat gold signify husband and wife... in turn, the bands are joined together by the synthetic birthstone of the month for each child in the family. THERE IS ONLY ONE "MOTHER'S RING." IT IS so distinctive, so unique, that it has been awarded U.S. Patent #186,183. Ask for it by name, confirm it by its identifying tag.



USE YOUR CREDIT

**SHOOR Jewelers**  
 YOU CAN BE SURE AT SHOOR'S  
 917 MAIN STREET—MANCHESTER  
 OPEN THURS. TO 9 P.M.

## Jewish Life Feature Of Homes Tour

**SOUTH WINDSOR**  
 Judy Kuehnel  
 Temple Beth Hillel Sisterhood of South Windsor will hold a Judaism in the Home Tour Sunday, May 18 from 1-4 p.m.

Traditional holiday foods will be sampled at the individual homes and coffee and dessert will be served at the Temple at the conclusion of the tour.

Homes open for the tour are those of Mr. and Mrs. Steven Berman, 23 Alpine Dr., Sabbath Home; Mr. and Mrs. Alan Dworky, 66 Tumblebrook Dr., Channah Home; Dr. and Mrs. Michael Goodman, 29 Charis Rd., Arts and Simcha Home; Dr. and Mrs. Harold Hutensky, Passover Home; and Mr. and Mrs. Allan Pilver, 68 Fairview Dr., Wedding Home.

Tickets are available in advance for \$2 or at the door for \$2.50.

Special discounts are available for religious school groups. For tickets or further information contact Andy Siegel, 528-6019; Roberta Black, 644-6768; or Phyllis Freeman, 644-1130.

Tickets may also be purchased in advance at Frank's Pharmacy, Oakland Rd., South Windsor.

## MANCHESTER MEAT MARKET

51 BISSELL ST. (rear)  
 OPEN TUES., WED., FRI., SAT. 9:00-5:30 PM  
 THURS., SUN. 8:00 P.M. (no requirement, & Mon.)

"The REAL Butcher Shop in Manchester..."  
 Specials Are Good thru Saturday, May 3rd  
 COME IN AND COMPARE OUR LOW, LOW PRICES FOR THE HIGHEST QUALITY BEEF IN THE AREA!

U.S.D.A. CHOICE FIRST CUT **CHUCK STEAK 59¢**  
 U.S.D.A. CHOICE EXTRA LEAN, 100% BEEF **GROUND CHUCK PATTIES 99¢**  
 In 2 and 4 Lb. Boxes lb.

LEAN AND TENDER **BEEF CUBES FOR STEW \$1.29**  
 U.S.D.A. CHOICE **SHORT RIBS OF BEEF 89¢**  
 Ideal for Brazing! lb.

OUR OWN MAKE **ITALIAN SAUSAGE \$1.09**  
 Hot or Sweet lb.

For your Freezers we have U.S.D.A. Choice Hindquarters and 1/2 Hindquarters, Sides and 1/2 Sides of Beef. All freezer orders are cut, wrapped and blast frozen at NO EXTRA CHARGE!  
 ASK ABOUT OUR LOCKER SPACE THAT WE HAVE FOR RENT!

# Anderson-Little

## Sale!... Sportswear

FOR MISSES and JUNIORS

### Separates that go-together

All in the finest machine washable 100% polyester double knits for a totally impressive fashion look. Choose from the newest fashion colors.

Versatile **Shirt Jacket** Our Reg. \$12 **9.95** SIZES 8-20  
 Superbly tailored shirt jackets featuring placket fronts, patch pockets and button cuffs. In solid colors to coordinate with your choice of pull-on pants.

Coordinating **Pull-on Pants** Our Reg. \$7 & \$8 **5.95** SIZES 8-20  
 The perfect match! Color-matched solid pants or smart novelty patterns for a coordinated look. Easy fitting. Proportioned for Petite, Average, Tall.

Popular **Pull-on Skirt** Our Reg. \$6 & \$7 **4.95** SIZES 10-20  
 Complete your wardrobe with matching skirt. Classic flare with stitched seam detail or swingy 8-gore full flare. Proportioned for Petite, Average, Tall.

Long sleeve Jersey **Print Shirts** Our Reg. \$9 & \$10 **7.95**  
 Classic Tailored shirts in soft supple jersey knits. Bright and breezy prints to complement every outfit.

Our Reg. \$6 & 7 **SUNSATONAL TOPS!** **4.95**  
 Great casual polyester and poly/cotton knits top everything! Classic placket fronts, twin sets, tees and many more fashion styles in solids and prints.

Our Reg. \$11 **BETTER PANTS!** **8.95**  
 Texturized wovens and polyester double knits. In solids & novelty patterns. Wide choice of fashion details including fly-front, stitched creases and button-tab trims.

Our Reg. \$17 to \$20 **PANT COATS** **13.95 to 16.95**  
 Water-repellent polyester and cotton oxfords in smart double-breasted, single-breasted, belted and many other fashion styles.

**Anderson-Little**  
 A Great Name in Fine Clothing  
 MANCHESTER Manchester Parkade

30 APR 30



Bill Mumford plays the banjo while Louise and Beth Vogel sing during rehearsal for this weekend's musical. It will be held at the Bolton Elementary School at 8 p.m. Donations are \$2 for adults and \$1 for children. (Herald photo by Holland)

### Bolton Church Plans Revue

**BOLTON**  
Donna Holland  
Correspondent  
646-0375

The St. Maurice Church parish will sponsor a musical revue Friday and Saturday at the Bolton Elementary School. The musical revue "Anything Goes" will feature songs and dances of yesterday, today and tomorrow.

Curtaintime will be 8 p.m. Donations will be \$2 for adults and \$1 for children under 12.

Proceeds from the event will go toward the parish debt reduction. There will be door prizes.

The show chairman is Margaret Manegia. She is being assisted by David Lyons. Mike Wilson is the guest musician and he will be assisted by Mike Mumford.

Children performing in the show are Andrea Pinto, Jennifer

### Scouts To Take Part in Bicentennial Marathon

**HEBRON**  
Anne Dallaire  
Correspondent  
228-2267

All Hebron Girl Scouts, Brownies, Juniors, Cadettes, and adults will participate in the Bicentennial Marathon and Field Day, Saturday, May 3.

This will be the first event in the Girl Scout observance of the National Bicentennial, and both events will be held rain or shine.

The marathon is a countywide event, covering all 83 communities with the jurisdiction of the Connecticut Council of Girl Scouts. After the marathon has passed through the center of Hebron, all scouts, families, and any other interested persons, will go to the Hebron Elementary School for games, scouting exhibits, picnic lunches and a brief formal program.

All Scouts and Brownies will be welcome to bring a box lunch to the school auditorium at noon, to view displays and take part in a short program.

If any one has any questions he can contact Mrs. James Derby at 646-8703 or Mrs. Charles Wallace at 537-5343.

The Senior Choir of the First Congregational Church and the Men's Fellowship will again sponsor the annual Smorgasbord from 4 to 6 p.m. May 17.

### Rivers Promises Dump Study Unit

**BOLTON**  
Donna Holland

Leon Rivers, Democratic candidate for first selectman, said although he has tried on several occasions to have a dump study committee appointed he has met with strong opposition from the present first selectman (Richard Morra) and the Republican candidate for first selectman (Dave Dreselly).

He said the present situation of the removal of refuse from Bolton is a matter of great concern to a large number of people.

Rivers said his opposition stated there is no need for a study committee because the town knows it needs a refuse area.

He said, "I feel there is a definite need for a committee because there is more than the need for a refuse area to be considered."

"The present situation may be the result of a locked-in set up by the first selectman of Andover and Bolton."

"I don't believe we have been able to see all of the forest because of some of the trees."

Rivers said he favors the expansion of the Board of Selectmen to a study group that will include interested residents and or representatives from town organizations in order to bring new light to the problem the town is now faced with.

He said if he is elected first selectman he intends to make the idea a reality.

### Mrs. Potterton Cites Record As Tax Collector for Bolton

**BOLTON**  
Donna Holland  
Correspondent

Elaine Potterton, Republican incumbent tax collector, today cited her record as Bolton's tax collector for the past four years.

Mrs. Potterton said that collections of 98.7 per cent of total taxes billed two years ago was a record for the country that year. She said in other years the percentage of taxes collected has averaged slightly above 98 per cent.

She said back taxes being collected in the past several months are running at a higher rate than ever, making it likely collections for this fiscal year will again exceed the 98 per cent mark.

She places as her number one priority her obligation to keep collections at a high percentage rate which can only be done by running an efficient office.

The tax collectors office is now open three days and one night a week except during the months of June, July and August when it is open five days and one evening.

Mrs. Potterton foresees the need to increase the number of hours the office is open each week in the near future.

Mrs. Potterton said she is proud of her record as tax collector and hopes to continue in the job for another two years.

### Schools Get Funds For Two Projects

**BOLTON**  
Donna Holland  
Correspondent

The Bolton Elementary School and Bolton Center School instruction improvement committee submitted funding proposals to the Schools Humanistic Individual Programs/Individual Guided Education (SHIP/IGIE) League in February and had two project components funded for implementation.

The first, a cooking unit on wheels, will give students the opportunity to reinforce known skills and promote new learnings in nutrition, food needs of the body and healthy snacks; safety, handling of utensils and care of electric appliances; health, cleanliness of food handling, sanitary care and storing of equipment.

Also in math sequence, measurement, counting, reading, following directions, vocabulary building; creative arts, designing a cookbook; newspaper, comparative shopping, food pricing; science, why things happen, yeast rising, mold growth; social studies, where foods come from.

The second, math carnival booth, will allow students to demonstrate their interest by practical use of real money at a penny carnival, learn to make change, develop a basic understanding of how our economic system works and show a real life need for cooperative team effort.

The movable units and accompanying materials will cost \$35.

### good news a 'ray' of the many bright ideas for your sun season!

**tee' off your summer with Jantzen's breezy 'Tee-Birds'... cool, carefree cotton blend knits...**

Easy-going, smart pants to wear on the 'course', or anywhere on land or sea! Dacron® polyester/cotton in sun-worthy shades of turquoise, apple green or canary. 8-18, S,M,L,XL. Shirt-jacket, \*23, Sleeveless "Liberty Print" Top (cotton), \*14, Front-Wrap Pullover, \*18, Sleeveless Placket Shirt, \*11, Tie-Back Jacket, \*12. Pull-On Shorts, \*10. Sportswear, downtown and parkade.

"Use your convenient Worth's Charge Card...it deserves a lot of Credit!"

Downtown  
Mon-Tue-Wed-Fri-Sat. 9:30-5:30  
Thur. 9:30-9  
Parkade  
Mon-Sat. 10-8  
Tue-Wed-Thur-Fri 10-8

**Worth's**  
SMILING SERVICE

really good news from Worth's

### Reading Program Open To Outside Students

**BOLTON**  
Donna Holland  
Correspondent

The Bolton Summer Reading Program will admit those students attending independent schools if they meet the student selection criteria.

The program is for children in kindergarten through Grade 6.

Parents having children attending an independent school who feel their child has a need for the program are asked to call the office of Bolton Elementary School by Thursday.

They will be given an appointment to have their child tested. All students eligible, from either public or private schools will be invited to participate in the program. Invitations will be mailed May 9.

The five-week program will run from July 8 until Aug. 8. It will serve 74 students.

Umpires Needed  
Umpires are needed for girl's softball games and boy's farm league. Little League and pony league baseball games.

Anyone interested in umpiring is asked to call Harvey Harpin, 649-8666.



Participants of the recent groundbreaking for the \$107,000 fire station off Gehring Rd. are: Selectman Kevin Cavagnah; building committee chairman Robert Clough; Town Manager John Harkins; and Fire Chief Ronald Littell. Shown in the back are Roger Gallher, architect; William Jamison, superintendent of the job; and Alphonse Patrick, general contractor of Building Innovations, Inc. (Photo by Lentocha)

### Ms. Stave Objects to WRPA Fund Cut

**COVENTRY**  
Monica Shea  
Correspondent  
742-9495

Sandra Stave, chairman of the Planning and Zoning Commission, expressed her displeasure Monday with the cut made by the Town Council in the town's annual contribution to the Windham Regional Planning Agency.

In an attempt to save money in the upcoming budget, the council cut its contribution to the agency by \$83, paying \$500 in annual dues rather than the \$1,131 assessed to the town by the agency on a per capita basis of 13.9 cents per person, using 1970 census population.

The cut, if not restored, could jeopardize the agency's reopaving state and federal planning grants because the agency must provide matching funds totaling \$7,480 from local contributions.

Ms. Stave said, "This cut could knock the agency funding right out the window. I am appalled that the council did this without the knowledge of the Planning and Zoning Commission. I think we should send the council a letter asking it to restore the cut and to ask that we be notified in the future of any such action to be taken by the council that would affect the Windham Regional Planning Agency."

"It is my understanding that the council decided to make the

### Community Growth Topic of Seminar

**COVENTRY**  
Monica Shea  
Correspondent

Manuel S. Emanuel, president of the Emanuel Association, Inc. of Nyack, N.Y., will be the guest speaker at a seminar on controlling community growth.

Emanuel was the major consultant to the town of Ramapo, N.Y. in its development of a planning program and managing growth program.

The Ramapo Plan is one of the first managed growth programs in the country, and it has been upheld by New York state's highest court.

The plan allows the town to freeze the development of vacant land for up to 18 years until the town is prepared to provide schools, sewers, roads and other services.

At issue was the town's fear of the sprawl of subdivisions that might strain the community's resources and character versus the questions of the landowners' rights.

The seminar is part of a series being sponsored by the Planning and Zoning Commission and the Institute of Urban Research at the University of Connecticut.

The seminar will be held in the Town Hall tonight at 8 p.m. and the public is invited to attend.

### Tolland Scouts Join Celebration Marathon

**ROCKVILLE**  
HOSPITAL NOTES

Admitted Tuesday: Helen Brooks, Cedar St., Rockville; Frances Caywood, Mountain St., Ellington; Bruce Clements, River St., Rockville; Winifred Daigle, Elm St., Rockville; Bernis Farney, West Rd., Ellington; Dianne Graner, Somers; Janet Guard, Hemlock St., Manchester; Lawrence Hodges, Regan St., Rockville; Alfred Judge Sr., Lawrence St., Rockville; William MacDonald, Bancroft Rd., Rockville; Ruth Menard, W. Main St., Rockville; Marie Purdie, Crystal Lake Rd., Vernon; Shari Schaulfer, Regan Court, Rockville; Nancy Schneider, Robin Rd., Vernon; John Simpson, Stafford Springs.

Discharged Tuesday: Andrew Curtis, River St., Rockville; Catherine Gagne, Glenwood Rd., Ellington; Milton Hansen, Windsor; Irene Harvey, West Willington; David Ignatowicz, Pleasant St., Rockville; Elisa Loujten, Sunnyside Dr., Vernon; Mrs. Christine Lewis and daughter, Dogwood Lane, South Windsor; Amelia Miner, Windsor Lane, Rockville; Beverly Ransom, West St., Rockville; Pia Stoeder, Cider Mill Rd., Ellington; John Skerrett, Union.

### Memorial Day Parade To Have Sober Theme

**BOLTON**  
Donna Holland  
Correspondent  
646-0375

Norman Preuss, chairman of the Memorial Day Parade committee, said he has contacted several groups planning to participate in the local Memorial Day parade to explain what would be permitted in the parade.

He said Memorial Day is a special day, a time when homage is paid to our deceased veterans and therefore, all fun items, including candy throwing, are eliminated.

Preuss said anyone who would like to participate in the parade by having a float is more than welcome to do so as long as the float is significant to the occasion.

He said the committee would appreciate more people becoming involved.

REPEATED BY POPULAR DEMAND...

# SPECIAL PURCHASE!

**MEN'S SUMMERWEIGHT SPORTCOATS**  
solids, checks, plaids, stripes  
36-46 reg. longs, shorts  
REGULAR TO \$60.  
**\$29<sup>88</sup>**

**MEN'S FAMOUS BRAND DOUBLEKNIT SLACKS**  
SOLIDS and PATTERNS 32-42  
REGULAR TO \$20:  
**\$11<sup>88</sup>**

entire stock VAN HEUSEN TIES reg. to 7.50  
2 for 5<sup>00</sup>  
stretch SOX reg. 1.50 3 pair 3<sup>00</sup>

famous name short sleeve DRESS SHIRTS 100% polyester blue, mint, tan, yellow, 14<sup>2</sup>-17 reg. 10.  
**\$6<sup>88</sup>**

select group discontinued famous name men's SHOES 20% OFF

famous brand corduroy JEANS 4 colors 28-42 reg. 14. **\$9<sup>88</sup>**

## REGAL MEN'S SHOP

"CONNECTICUT'S LARGEST and MOST COMPLETE MEN'S STORE"

903 MAIN ST., MANCHESTER open daily till 5:30 P.M., Thursday till 9 P.M.







TRI-CITY PLAZA, VERNON open daily till 9 P.M., Saturday till 5:30 P.M.

**BOY SCOUT SUPPLIES**  
and EQUIPMENT HEADQUARTERS  
**ZAHNER'S MEN'S SHOP**  
DOWNTOWN ROCKVILLE

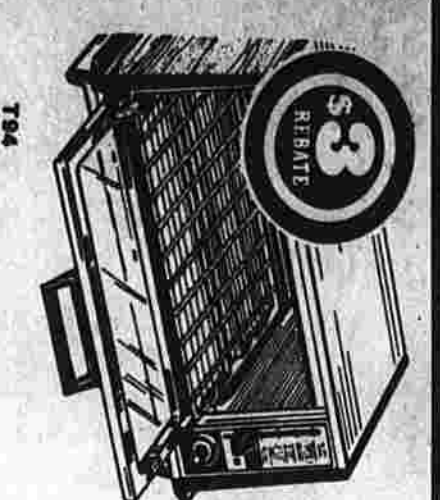
**MOBILE HEATING OILS**  
Oil Burner & Heating Installation  
643-5135

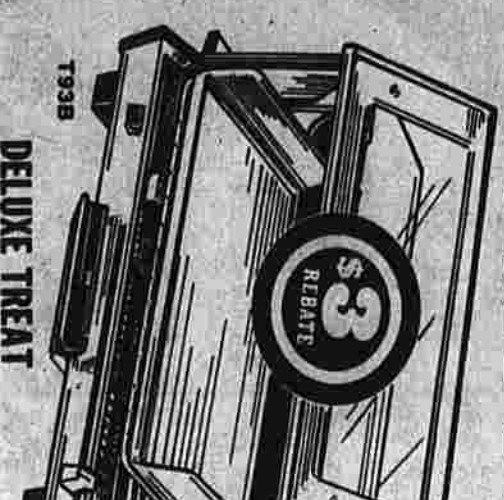
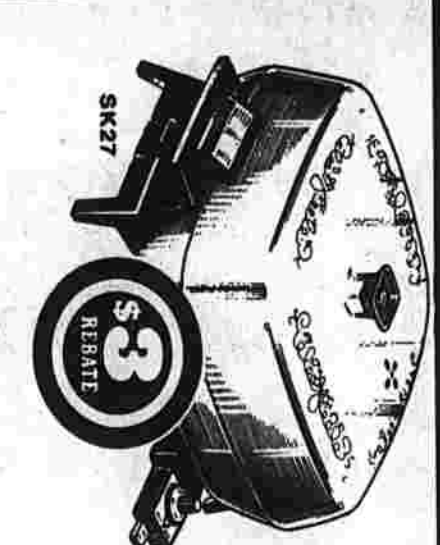
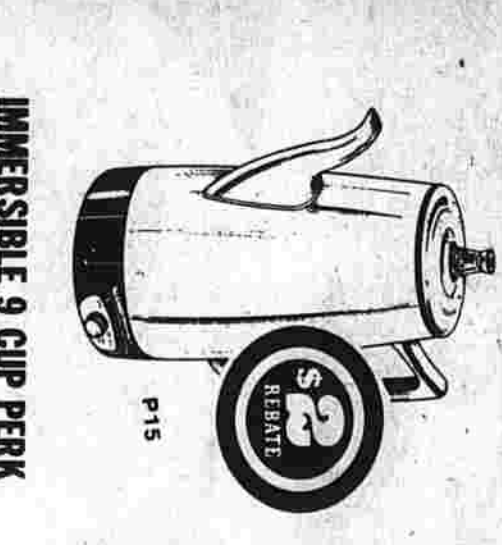

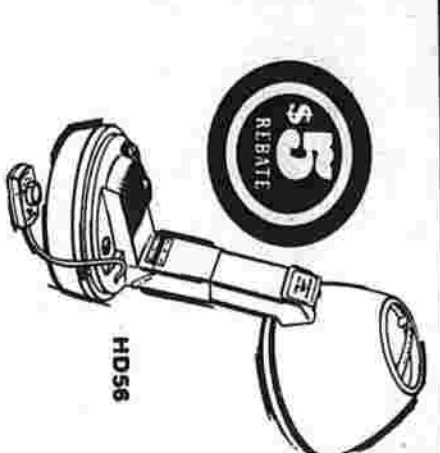
## FACTORY REBATE DAYS

<p><b>3288</b> LESS: 3</p> <p>TOAST-R-OVEN® KING SIZE</p>  <p>Model 1784 Rebate Offer Ends May 18, 1975</p>	<p><b>1498</b> LESS: 2</p> <p>TOUCH &amp; CURL® MIST CURLER</p>  <p>Model CS1 Rebate Offer Ends May 18, 1975</p>	<p><b>2688</b> LESS: 3</p> <p>DELUXE TREAT TOAST-R-OVEN</p>  <p>Model 1732B Rebate Offer Ends May 18, 1975</p>
<p><b>2269</b> LESS: 3</p> <p>12" FRYING PAN DOME TOP</p>  <p>Model 91427 Rebate Offer Ends May 18, 1975</p>	<p><b>1898</b> LESS: 2</p> <p>IMMERSIBLE 9 CUP PERK</p>  <p>Model P15 Rebate Offer Ends May 18, 1975</p>	<p><b>\$3</b> REBATES <b>\$5</b> REBATES</p> 
<p><b>1997</b> LESS: 5</p> <p>SALON POWER HAIR DRYER</p>  <p>Model H1958 Rebate Offer Ends May 18, 1975</p>	<p><b>1288</b> LESS: 3</p> <p>HEATED CREAM DISPENSER</p>  <p>Model SC01 Rebate Offer Ends May 18, 1975</p>	<p><b>2298</b> LESS: 3</p> <p>SELF-CLEANING STEAM/SPRAY DRY IRON</p>  <p>Model FT10-WH Rebate Offer Ends May 18, 1975</p>

### Clown Town Fund Raiser Saturday

**VERNON**  
"Clown Town," the major annual fund raising project of the Suburban Women's Club of Vernon, Ellington, and Tolland, is scheduled Saturday from 10 a.m. to 4 p.m. at the Vernon Middle School, Rt. 30.

The beer fest which traditionally follows Clown Town will be at St. Bernard Church hall from 8 p.m. to midnight.

In a request to the people in the three towns to support these projects, Vernon Mayor Frank McCoy said the all-day affair not only allows children and adults to enjoy themselves but also enables them to contribute to this worthy project which is especially relevant in this time of economic recession.

He said that in the last six years the club has contributed more than \$30,000 to area charities and most of that money came from Clown Town activities.

Clown Town is a circus-type fun day and a Dixieland band will be featured at the beer fest.

**Plant Sale**  
The Women's Fellowship of Union Church will conduct a plant sale in the church parking lot, Elm St., Rockville, May 16 from 9 a.m. to 3:30 p.m.

On sale will be a variety of house plants, annual flowers, geraniums and vegetable plants.

If anyone wants to order ahead he may pick up an order form at the church office or call the office by May 11. The number is 975-2559.

**Macrame Course**  
A course in macrame for 10- to 15-year-olds will be offered by the Indian Valley YMCA starting Saturday. Those interested must be preregistered by May 7.

The class will run for five consecutive Saturdays from 10 to 11:30 a.m. During this time students will complete a plant hanger, a bottle cover, and a belt. Mrs. Pat Garratt of Vernon will conduct the class. The fee for "Y" members will be \$6 and may be purchased from members of the association or at the Talcottville School, Main St., Talcottville.

The drawing will be at the Moose Club, Kingsbury Ave., May 16 at a dinner-dance. Music will be by the Al Jarvis band. Tickets for this event are \$10 per couple.

Anyone wishing to make reservations should call one of the following numbers: 645-4778; 872-6483; or 645-4979.

**Emblems Club**  
The Rockville Emblem Club will sponsor a dance May 9 starting at 9 p.m. at Mt. Carmel Hall, Roberts St., East Hartford.

Tickets will be \$10 a couple and those attending must bring their own liquid refreshments. Set-ups will be provided.

Emblems are available from Mrs. Donald DeVine, 645-1384 or at the Rockville Elks Home, N. Park St.

**Craft Show**  
The Ellington Junior Women's Club will sponsor its second annual Arts and Crafts Show, on the green, May 31 from 10 a.m. to 6 p.m. The rain date will be June 1 from noon to 8 p.m.

Mrs. Sue Kueidig, chairman

## The Herald

Area Profile

### Bicentennial Theme Of Vernon Pageant

"This Land is Our Land," will be the theme of a special Bicentennial pageant to be presented Saturday at 7:30 p.m. at the Vernon Center Middle School, Rt. 30.

The show is an original musical and dramatic production which will encompass many events of the nation's past 200 years.

Of more than 100 persons will appear in various acts throughout the evening. The show will get under way with a rollicking musical number focusing on the signing of the Declaration of Independence.

Other acts in the show will focus on the settlers going west, the Civil War, the "Roaring 20s," the inventors of that period, the "Slick 50's," the space age, and right up to today.

The grand finale will be a sing-a-long featuring favorite American songs. Tickets will be sold at the door. All seats will be \$1 and the show is to start promptly.

now's the time to renew the webbing in your lawn chairs and chaises!

Fairway has the webbing, screws and clips!

(chooses from 6 colors)

17 ft. package ..... \$3.99  
72 ft. package ..... \$1.59  
(two small packages will do one chair)

**FAIRWAY** "where a dollar's worth a dollar!"  
the miracle of main street downtown manchester

## TERMITES Swarming - call BLISS



BE SURE... BLISS has been serving the Home Owner for 93 YEARS. For a complete FREE INSPECTION of your home by a Termitic Control Expert, supervised by the finest technical staff, phone our nearest local office:

**649-9240**

**BLISS TERMITE CONTROL CORP.**  
DIV. OF BLISS EXTERMINATOR CO., INC. - EST. 1882  
The Oldest & Largest in Conn.

## martin ltd.

men's and young men's apparel  
FINEST LABELS IN MEN'S CLOTHING

We Carry These Nationally Advertised Brands:

- Hart, Schaffner & Marx
- Austin Reed
- London Fog
- Pendleton
- Zero King
- Izod
- Stanley Blacker
- Damon
- John Weitz
- Enro
- Arrow
- Cortefiel
- Jaymar
- Haggar
- Pringle
- Levi
- Johnny Carson
- Palm Beach
- Freeman and Many Others

### Headquarters for Leisure Wear featuring from our large collection...

## VANTAGE POINTS

This Haggar® slacks and top combination proves that winning form isn't only on the courts.

The top combines a gabardine twill with square flap pockets, deep side vents and contrasting stitching for only \$22.50. It's available in a variety of rich solid and pastel colors to match or contrast with the corduroy slacks.

The slacks feature Haggar's Comfort-Plus® styling that includes fashion pockets and hemmed bottoms with a gentleman's flare for only \$16.

Both are a machine washable and dryable textured woven of 100% Dacron® polyester.

A complete Haggar outfit for only **\$38.50**



Looking good makes you feel good.

## WOODWORKS

ORGANIZATION: WED., THURS., FRI., SAT. BUILDING MATERIALS

**48-FT. 3/4"-IN. VINYL-FINISH WALL PANELS**  
Our Reg. 10.47  
**8.47**

Durable vinyl finish on hardboard with a decorative woodgrain pattern. Easy to install. See Change #11.

**48-FT. 1/2"-IN. MELTLINE ON HARDBOARD**  
Our Reg. 10.47  
**7.97**

Easy-to-clean, sanitary. Durable. See Change #11. White Melamine Top. See Change #11.

**ALL FIRST QUALITY - NO SECONDS**  
48-FT. 1/2"-IN. PANELING  
**WOOD-GRAIN-LOOK LUALUN**  
Our Reg. 6.77  
**5.77**  
4 Days

Bring rich, new drama to your rooms with the melamine beauty of wood-grain paneling. Available in a variety of finishes. Easy-to-install. See Change #11.

**STANDARD 8-FT. 2x4s**  
89¢

Finished for rough lumber construction in home, or other.

Good one side for 4x8 1/2" x 2" plywood

**PRE-MIX CONCRETE**  
5.97

40 lb. bags. 100% ready to use. See Change #11.

**DISAPPEARING STAIRWAY**  
Our Reg. 29.77 - DMS  
**\$24.77**

Handicapped friendly. Great for stairs. See Change #11.

**CONSTRUCTION ADHESIVE**  
11 oz. tube. Easy-to-use.  
**68¢**

**MULTI-PURPOSE POLYETHYLENE**  
Our Reg. 2.88 - 3.50 per lb.  
**1.97**

Protective. See Change #11.

**CUSTOM WHITE 12" GELING TILE**  
Our Reg. 35.00 - 40¢ per sq. ft.  
**22¢**

Strength, easy-to-install. All the features of a real tile. See Change #11.

## MAY FABRIC SALE

**CALICO PRINTS**

Great selection of designs, colors in "Country Look" Calico prints - the old "new" look for spring. 100% cotton.

Machine wash - Tumble dry  
44"/45" wide.  
VALUES TO \$1.98 YD.

**.99** YD.

**BICENTENNIAL PRINTS**

Patriotic motifs plus florals and solids for the "All American" look. These seersucker prints are 100% cotton.

Machine wash - Tumble dry  
38"/39" wide.  
**1.69** YD.

**100% DACRON® POLYESTER DOUBLE KNITS**

"PONTE ROMA STITCH"

Choose from a variety of all new spring colors. Great for dresses, pants and sportswear. Machine wash, tumble dry.  
60"/62" wide.  
VALUES TO \$3.98 YD.

**188** YD.

**QUILTED CALICO PATCHWORK**

Perky "Country Fair" prints. Perfect for any time of the year. Great for decorators and bedspreads. Machine wash, tumble dry. 100% cotton. Polyester fill - Tricot back.  
44"/45" wide.  
MATCHING UNQUILTED . . . 1.98 YD.

**298** YD.

**WISS CONTURA-LITE SHEARS**

Comfortable contoured handles. Will cut multiple thickness of all fabrics. Attractive gift packaging with a Wiss money back guarantee.  
Regular price: \$8.95 pair.

**5.97** PAIR

**IRON-ALL PRESSING ATTACHMENT**

Prevents scorching and shine. Fits most steam or dry irons. Distributes heat and steam evenly. Money back guarantee.  
Regular price: \$3.50 each.

**2.77** EACH

**GIVE MOTHER A GIFT CERTIFICATE**

We Honor Master Charge or Bank Americard Charge Cards

## SO-FRO FABRICS

always first quality fabrics

BURR CORNERS SHOPPING CENTER  
OPEN DAILY  
TEL. 648-7728

TRI-CITY PLAZA  
VERNON  
Open Daily 10-9; Sat. 10-4  
TEL. 875-2417

## after Six

Formal Rentals

OPEN DAILY 'TIL 9 P.M.  
MANCHESTER PARKADE  
MANCHESTER  
FARMINGTON VALLEY MALL  
SIMSBURY-AVON

## martin ltd.

30 APRIL 30





### STANDINGS

National League	
East	West
Chicago	6
Pittsburgh	5
Philadelphia	3
Cincinnati	3
St. Louis	2
Atlanta	1
San Francisco	1
Houston	0

CHICAGO (UPI) — The New York Mets were almost apologetic today for handing the Chicago Cubs a 9-1 loss in the opener of their three-game series.

## Mets Almost Apologetic After Trouncing Chicago

"I got a little tired and had to kick myself in the butt to get going again. Then Dave (Kingman) made that catch and that picks you up and gets you out of the inning."

## Messersmith Delivers Both on Mound, at Bat

NEW YORK (UPI) — "When I go to the plate," said Los Angeles hurler Andy Messersmith, "I don't like to embarrass myself."

## South Jayvees Trim Eagles

Coming up with eight runs in the first two innings, the South Cayote jayvee baseball team downed East Hill, 11-6 yesterday at Hartford's Goodwin Park.

## Pro Hockey Roundup

### Supporting Cast Gains Limelight

NEW YORK (UPI) — Supporting players took over the spotlight in Stanley Cup playoff action Tuesday night as a semifinal matchup began with a surprise, then ended as expected, while the other continued to be a surprise.

## King Retires

NEW YORK (UPI) — Betty King ended a major league career of 46 years standing with New York baseball today, retiring after a game in which he was announced her retirement.

## Houston Game Away From Berth in Finals

NEW YORK (UPI) — Mark Howe started the Aeros' scoring midway through the first period and Hines got his first score less than two minutes later.

## Hood Wins First Start

NEW YORK (UPI) — Don Hood knew the Cleveland Indians were looking for a left-handed starter and so he was upset about being traded from the perennial first-place Baltimore Orioles prior to the 1975 baseball opener.

## White and Jennings Cop Racquet Tourney

Teaming up to annex the Men's Doubles Tournament championship at the Manchester Racquet Club were Mike White and Stu Jennings.

## American League Roundup

### Horton Satisfied As Detroit's DH

NEW YORK (UPI) — Add Willie Horton to the list of veteran players who would find that life as a designated hitter can be fruitful.

## Noses Into Derby

LOUISVILLE, Ky. (UPI) — Hobson Farm's Round Stable, sent off as a 9-10 favorite, nodded his way into Saturday's Kentucky Derby with a victory at the wire Tuesday in the 141,000 Derbys Trial at Churchill Downs.

## Girls' Softball Team Winner

Copping its second victory in three starts yesterday was the Manchester High girls' softball team with an 8-6 drubbing over Pease High at Fitzgerald Field.

## MAJOR LEAGUE BOXSCORES

AMERICAN LEAGUE	
Detroit	
White	1
Jennings	1
Trotter	1
Doornick	1
Tracy	1
Howe	1
Harmon	1
McClellan	1
Carp	1
St. Louis	6
White	3
Horton	1
Harmon	1
McClellan	1
Carp	1
St. Louis	6
White	3
Horton	1
Harmon	1
McClellan	1
Carp	1

## MAJOR LEAGUE LEADERS

National League	
St. Louis	14
San Francisco	12
Atlanta	11
Philadelphia	11
Cincinnati	10
Chicago	9
Pittsburgh	8
Houston	7
Los Angeles	6
San Diego	5
Montreal	4

## White and Jennings Cop Racquet Tourney

Teaming up to annex the Men's Doubles Tournament championship at the Manchester Racquet Club were Mike White and Stu Jennings.

## American League Roundup

### Horton Satisfied As Detroit's DH

NEW YORK (UPI) — Add Willie Horton to the list of veteran players who would find that life as a designated hitter can be fruitful.

## Noses Into Derby

LOUISVILLE, Ky. (UPI) — Hobson Farm's Round Stable, sent off as a 9-10 favorite, nodded his way into Saturday's Kentucky Derby with a victory at the wire Tuesday in the 141,000 Derbys Trial at Churchill Downs.

## MAJOR LEAGUE BOXSCORES

AMERICAN LEAGUE	
Detroit	
White	1
Jennings	1
Trotter	1
Doornick	1
Tracy	1
Howe	1
Harmon	1
McClellan	1
Carp	1
St. Louis	6
White	3
Horton	1
Harmon	1
McClellan	1
Carp	1
St. Louis	6
White	3
Horton	1
Harmon	1
McClellan	1
Carp	1

## Indians Track Winners With Fine Team Effort



## White and Jennings Cop Racquet Tourney

Teaming up to annex the Men's Doubles Tournament championship at the Manchester Racquet Club were Mike White and Stu Jennings.

## American League Roundup

### Horton Satisfied As Detroit's DH

NEW YORK (UPI) — Add Willie Horton to the list of veteran players who would find that life as a designated hitter can be fruitful.

## Noses Into Derby

LOUISVILLE, Ky. (UPI) — Hobson Farm's Round Stable, sent off as a 9-10 favorite, nodded his way into Saturday's Kentucky Derby with a victory at the wire Tuesday in the 141,000 Derbys Trial at Churchill Downs.

## MAJOR LEAGUE BOXSCORES

AMERICAN LEAGUE	
Detroit	
White	1
Jennings	1
Trotter	1
Doornick	1
Tracy	1
Howe	1
Harmon	1
McClellan	1
Carp	1
St. Louis	6
White	3
Horton	1
Harmon	1
McClellan	1
Carp	1
St. Louis	6
White	3
Horton	1
Harmon	1
McClellan	1
Carp	1

## Indians Track Winners With Fine Team Effort

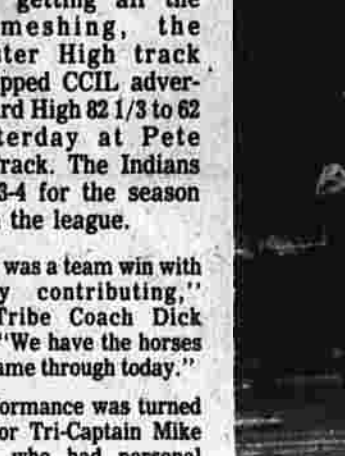

## White and Jennings Cop Racquet Tourney

Teaming up to annex the Men's Doubles Tournament championship at the Manchester Racquet Club were Mike White and Stu Jennings.

## American League Roundup

### Horton Satisfied As Detroit's DH

NEW YORK (UPI) — Add Willie Horton to the list of veteran players who would find that life as a designated hitter can be fruitful.

## Noses Into Derby

LOUISVILLE, Ky. (UPI) — Hobson Farm's Round Stable, sent off as a 9-10 favorite, nodded his way into Saturday's Kentucky Derby with a victory at the wire Tuesday in the 141,000 Derbys Trial at Churchill Downs.

## MAJOR LEAGUE BOXSCORES

AMERICAN LEAGUE	
Detroit	
White	1
Jennings	1
Trotter	1
Doornick	1
Tracy	1
Howe	1
Harmon	1
McClellan	1
Carp	1
St. Louis	6
White	3
Horton	1
Harmon	1
McClellan	1
Carp	1
St. Louis	6
White	3
Horton	1
Harmon	1
McClellan	1
Carp	1

## BOWLING

TRI-TOWN - Mike Felman 228-571, Paul Barton 210-546, Ben Bernavage 241-569, Bill Reichert 202-515, Joe Cappucci 208, John Miller 234-572, Dave Wohlgenuth 203-513, Mac McDonald 202-506, Art Rancourt 545, Bob Crowwell 553, Paul Pagnucca 528, Bruce Moyer 536, Rick Martin 515, Dave Neff 508, Ruth Smith 179-508, Dana Price 208-508, Sheila Price 190-458, Denise Crowwell 497, Margi Deslaine 468, Vivian Price 452, Beth Keonon 472, Be Moquin 463.

## Indian Netters Lose Opener

Downed in its opener Monday was the Manchester High tennis team, 6-1, by Hall High of West Hartford at the Indians' court. Senior Aronava, transfer out from Columbia, South America, won the opening singles match for Manchester but after that it was all downhill.

## White and Jennings Cop Racquet Tourney

Teaming up to annex the Men's Doubles Tournament championship at the Manchester Racquet Club were Mike White and Stu Jennings.

## American League Roundup

### Horton Satisfied As Detroit's DH

NEW YORK (UPI) — Add Willie Horton to the list of veteran players who would find that life as a designated hitter can be fruitful.

## Noses Into Derby

LOUISVILLE, Ky. (UPI) — Hobson Farm's Round Stable, sent off as a 9-10 favorite, nodded his way into Saturday's Kentucky Derby with a victory at the wire Tuesday in the 141,000 Derbys Trial at Churchill Downs.

## MAJOR LEAGUE BOXSCORES

AMERICAN LEAGUE	
Detroit	
White	1
Jennings	1
Trotter	1
Doornick	1
Tracy	1
Howe	1
Harmon	1
McClellan	1
Carp	1
St. Louis	6
White	3
Horton	1
Harmon	1
McClellan	1
Carp	1
St. Louis	6
White	3
Horton	1
Harmon	1
McClellan	1
Carp	1

# FARMIL CAR CARE CENTER

Route 83, Rockville Three Miles from Vernon Circle Exit 95 875-3379

**SEIBERLING PUTS YOU ON A BETTER ROAD WITH A ROADFUL OF RADIALS**

**SEIBERLING RT-78 DOUBLE STEEL BELTED RADIAL**

1. 40,000 mile warranty  
2. Free replacement for first 20% of tread life.  
3. Lifetime workmanship and road hazard guarantee.

SIZE	WHITWALL	PRICE	F.E.T.
C-78-13		\$25.75	\$2.02
C-78-14		26.11	2.10
E-78-14		27.73	2.32
F-78-14		29.12	2.47
G-78-14		30.73	2.63
H-78-14		33.09	2.84
J-78-14		34.42	3.02
F-78-15		29.12	2.55
G-78-15		30.73	2.69
H-78-15		33.09	2.92
J-78-15		34.42	3.09
L-78-15		36.43	3.21

## FOR RADIAL TIRE PERFORMANCE AT PRICES YOU CAN AFFORD

**SEIBERLING RADIAL G/N**

AS LOW AS

**\$31.75**

plus \$2.16 F.E.T.  
plus \$2.07 WhiteWall

SIZE	WHITWALL	PRICE	F.E.T.
FR-78-15		\$35.41	\$2.62
GR-78-15		37.39	2.95
JR-78-15		40.27	3.17
HR-78-15		41.87	3.30
LR-78-15		43.12	3.48

**BIG! BOLD! BRIGHT! LeMans Raised White Letter Tires! MATCHING LETTER STYLING IN BIG SIZES**

AS LOW AS

**\$26.75**

plus \$2.06 F.E.T.  
plus \$2.07 WhiteWall

SIZE	PRICE	F.E.T.
A-80-13	\$28.75	\$2.06
G-80-14	33.06	2.97
L-80-14	40.12	3.44
G-80-15	33.06	3.02
L-80-15	40.12	3.54

AS LOW AS

**\$28.75**

plus \$2.02 F.E.T.  
plus \$2.07 WhiteWall

SIZE	WHITWALL	PRICE	F.E.T.
F-70-14		\$28.75	\$2.62
G-70-14		30.58	2.77
G-70-15		30.58	2.85
G-70-15		30.58	2.87

**DEXTER** \$28.95

**GLENNY'S** Men's Shop  
789 Main Street  
Manchester • 643-8022

**APR 30**

### SCENE FROM HERE

By SOL R. COHEN

#### "I've Got This Friend..."

I've got this friend who plays tennis every chance he gets. It doesn't matter whether it's summer, winter, spring or fall. He plays tennis almost anytime at all. He's always asking me why I don't play.

What can I tell him—that I don't have the time, that I can't run like a once-colded that I don't like the game?

That last isn't entirely true. With all the tennis on TV these days, I've become a tennis buff and the hard way yet—a armchair tennis buff.

What a great way to spend a sunny, warm and calm Sunday afternoon—tennis by remote control, without the running or the puffing or the losing.

It's a great game, tennis, much more exciting on TV than golf, or even baseball. In my opinion, only basketball-watching and watching a wide-eyed schoolyard beating tennis-watching.

To see "Poker-face" Chris Evert beat the exciting Billie Jean King is a lesson in something or other.

And watching "Bad Boy" Jimmy Connors take on the likes of "Gentleman" John Newcombe takes me back to my old Humboldt Park bunch in Chicago, when it was shambles of the Lake Shore Drive swells—on the courts of the old Edgewater Beach Hotel.

I've even learned how to keep score in tennis. Something I never could do in French or Spanish.

I remember this one guy we had in the old Humboldt Park bunch. When he'd say, "Tennis, anyone?" he made it sound like a champagne party for the country club set. He's the same guy who affected a British accent, while still a freshman in

high school. How he'd dazzle the girls. They believed all through high school he was from Devonshire, that his father was a British consul and that he'd been accepted to Oxford.

It's only when he went to a school of accounting in Downtown Chicago, still with the accent (he never could get rid of it), that everyone caught on he was a put on.

Well anyway, I remember he got hold of two tennis racquets and a couple of beat up tennis balls one summer and there was no stopping him or whatever partner would play with him.

Our game of tennis was really handball with racquets. It's now called jail ball and has been approved for legalized betting by some states—including Connecticut.

We played in the school yard, hitting the ball up against the school building and making so much noise we were chased by the cops.

We'd go to school in the fall and brag how we spent the summer playing tennis.

I remember well that my friend got so taken with the game, he became the only boy in the neighborhood wearing white sneakers, red shorts and a blue t-shirt every chance he got. When November rolled around, he'd drape his sweater around his shoulders.

It didn't quite work out for him. He went to this school of accounting where the only sport was trial runs at a balance sheet.

He's now a successful CPA in Detroit and, come to think of it, keeping score in tennis might have had something to do with it.

Tennis, anyone?



Morris Budkofsky, grand junior deacon, right, shows Sterud the commission that was later presented to Sterud during the reception. At left is Roger W. Aher, associate grand marshal. (Herald photo by Dunn)

### Hosts Families Sought For Exchange Program

Host families are being sought in the Manchester area who wish to share their lives with a new son or daughter from another country.

The announcement was made by Mrs. Lee Bonderman, Youth for Understanding representative of Tolland.

One such young person looking for a short-term home is Brita, a 16-year-old girl from Stockholm, Sweden. She will be among 2,300 teenagers from Europe, South America and the Far East arriving this fall as part of the Youth for Understanding exchange program.

Youth for Understanding students become a member of their new family and have the same responsibilities and privileges as other children in the home.

Host families provide the necessities, such as food and housing, while students are responsible for their own personal expenses.

The announcement was made by Mrs. Lee Bonderman, Youth for Understanding representative of Tolland. It is dedicated to fostering greater international understanding by making it possible for young people to have an overseas family living experience.

Families interested in opening their home to a new student from Germany, Scandinavia, The Netherlands, Japan or one of 14 other countries may contact Mrs. Bonderman, Columbine Rd., Tolland, or phone 875-0001.

### Small Cars Proving Thrifty for Yankees

WELLESLEY, Mass. (UPI) — The driver of a compact car in New England spends \$700 less per year than the big car driver in the region, according to a cost study conducted by the AAA Auto and Travel Club.

The study showed the average New England motorist who drives his 1975 full-size car in Massachusetts 16,000 miles per year pays \$2,422.40 annually or 15.14 cents per mile to operate his car. If he drives a compact car, he spends \$1,715.20 annually or 10.72 cents per mile.

Massachusetts was the most expensive state in New England and one of the most expensive states in which to operate an automobile, according to the study.

The newly available 1975 edition of "What It Costs To Run A Car," the AAA's periodic survey of car-related expenses, reveals that the average per-mile cost of driving a 1975 full-size car in Massachusetts is 15.15 cents per mile. That is nearly a third of a cent per mile more than the New England average.

Overall per mile costs are then computed for each car based on 16,000 miles of driving annually, based on a three-year period of ownership.

### SOCIAL SECURITY

ATLANTA (UPI) — The committee of the Presbyterian Church in the U.S., working on a new confession of faith for the predominantly southern denomination, will ask the church's 1975 general assembly for another year to prepare a revised draft of the confession.

Q. I receive monthly Social Security survivors benefits for my daughter. She was killed. She is planning to get married. Will the continuation of benefits until she is 18 even after she gets married?

A. No. If monthly Social Security benefits will stop the month before she marries. You should notify the Social Security administration when the marriage plan to return her check if she received for that month.

Q. My 10-year-old son and I both received monthly Social Security benefits after my husband's death. When I remarried a year ago, my benefits stopped. Since my husband died last month I can again receive monthly benefits on my first husband's earnings record?

A. Call or visit your Social Security office to file a new application for benefits. You will need a certified copy of your divorce decree.

Q. I get Social Security payments as a widow. I do not work, but I own a small apartment building. Does my rental income count toward the \$2,500 a year that I can earn before Social Security payments are reduced?

A. No. Only wages and self-employment income count earnings for Social Security purposes. Rental income will not affect your cash benefits unless you are a real estate dealer.

Q. Before her recent death, my wife worked Social Security for nearly 11 years. Even though I plan to continue working and support our two children, aged 7 and 11, could they get monthly Social Security benefits on my wife's work record?

A. Yes. The children would be eligible for Social Security benefits on their mother's record regardless of your earnings. However, you may even be eligible for a father's benefit. Please call your Social Security office to check into this.

Have a question about Social Security and its retirement, survivors disability or Medicare benefits? Write to Questions Answers, 657 Main St., East Hartford, Conn. 06108.

### THE FAMILY LAWYER

Alienaid Parent

Alienation of a husband's affections is often based on grounds for contempt in a court of law.

But what about alienation of a parent's affections? Do the children have grounds for contempt? From time to time, claims of this kind have been successful.

In one recent case, two children filed suit against the "other woman" who induced their father to withdraw from his family. They argued that he had deprived them of not only his love and affection but all the comfort and security of family life.

Instead, the court awarded damages to the children. The court said that including the children as well as the response spouses. A child has an interest in the affection of the parent, at least while he remains in a household.

If for the most part, courts have awarded damages on such claims.

In another case, also brought by children against an "other woman," the court took the more traditional view. Except for financial support, said the court, a father's obligation to his children is honor—not legal.

The court stated that allowing alienation-of-affections claims by children "would place the love of the parent on a commercial level, as if there have been cases running in the opposite direction by a parent suing for alienation of the affections of a child. But by the courts have generally taken a dim view of such suits."

If forsaken parents filed old-time damages, observed the judge, it could forsaken brothers and sisters. The judge said it would open "a Pandora's box of litigation."

A public service feature of the American Bar Association and the Connecticut Bar Association. Written by Bill Bernard.

**AT FOOD MARTS YOU'LL GO HOME WITH A BIGGER BUNDLE FOR LESS MONEY!**

**SAVE ON YOUR NEXT MEAT PURCHASE WITH THIS COUPON**

**40¢ off** ON PURCHASE OF \$3.00 OR MORE **FRESH MEAT** LAMB - VEAL - PORK - BEEF OR POULTRY FROZEN AND CANNED MEAT NOT INCLUDED WITH THIS COUPON AT FOOD MARTS, GOOD THRU SATURDAY, MAY 3, LIMIT ONE COUPON PER FAMILY.

**TOP FROST MEAT PIES** CHICKEN - BEEF OR TURKEY **5 8 OZ. PKGS. \$1.**

**SHOULDN'T YOU REALLY SHOP FOOD MARTS... THE COST CUTTERS**

A CUT BELOW THE OTHERS IN PRICE. - A CUT ABOVE THE OTHERS IN QUALITY

**WALDBAUM'S Food Mart**

**5 TO 9 LBS. AVERAGE \$59<sup>¢</sup> LB.**

**OSCAR MAYER BUDGET SLIMMERS SALE!**

**WEINERS or BEEF FRANKS** 1 L.B. PKG. \$1.19

**Pork Sausage** 1 L.B. PKG. \$1.39

**ALL MEAT OR ALL BEEF Bologna** 12 OZ. PKG. 99<sup>¢</sup>

**Sliced Bacon** 1/2 L.B. \$1.69

**FULLY COOKED SEMI BONELESS HAMS** WHOLE OR HALF WATER ADDED **99<sup>¢</sup> LB.**

**Sliced Beef Liver** FROZEN 1 L.B. 59<sup>¢</sup>

**FLAVORFUL COLONIAL Sliced Bacon** 1/2 L.B. \$1.29

**Jimmy Dean - 1/2 OZ. ROLL Pork Sausage** 99<sup>¢</sup>

**OUR BEST BREADED VEAL PATTIES** 89<sup>¢</sup>

**MEAT OR BEEF FRANKS** 69<sup>¢</sup> L.B.

**SEASONED CORNED BEEF Briskets** 1 L.B. \$1.29

**Liverwurst or Bologna** 1 L.B. 89<sup>¢</sup>

**SEAFOOD SPECIALS!** FRESH SOLE FILLETS 1 L.B. \$1.89

**FRESH HADDOCK FILLETS** 1 L.B. \$1.79

**FRESH SCROD FILLETS** 1 L.B. \$1.29

**FRESHLY GROUND BEEF** 69<sup>¢</sup> L.B.

**PRIMO HOT OR SWEET ITALIAN SAUSAGE** \$1.09

**MONEY'S CRYING! CENTER CUT Corned Beef Briskets** 1 L.B. \$1.29

**COLONIAL - REG. OR FAMILY STYLE - CHUNK Liverwurst or Bologna** 1 L.B. 89<sup>¢</sup>

**SEAFOOD SPECIALS!** FRESH SOLE FILLETS 1 L.B. \$1.89

**FRESH HADDOCK FILLETS** 1 L.B. \$1.79

**FRESH SCROD FILLETS** 1 L.B. \$1.29

**FOOD CLUB SLICED CARROTS** 16 OZ. CANS **\$1.**

**PREMIER BUTTER** 1 L.B. 39<sup>¢</sup>

**HEALTH STRAINED BABY FOOD** ALL VARIETIES 15 OZ. JARS **69<sup>¢</sup>**

**SLYTE DIET SODA** ALL FLAVORS 16 OZ. BOTTLE **10<sup>¢</sup>**

**FOOD CLUB TROPICANA 100% FLORIDA ORANGE JUICE** 1/2 GAL. CARTON **65<sup>¢</sup>**

**KRAFT AMERICAN CHEESE** SINGLES - WHITE OR YELLOW **79<sup>¢</sup>**

**Food Club Flour** 5 L.B. BAG **59<sup>¢</sup>**

**Chocolate Morsels** NESTLES 12 OZ. PKG. **99<sup>¢</sup>**

**Duncan Hines Brownie Mix** 3 OZ. PKG. **99<sup>¢</sup>**

**Friskies Buffet Cat Food** ALL VARIETIES 5 16 OZ. CANS **\$1.**

**Glade Texture Wrap** 20 FT. ROLL **49<sup>¢</sup>**

**Glade Fresheners** ALL SCENTS CONTAINERS **3 FOR \$1.**

**Realemon Juice** QUART BOTTLE **49<sup>¢</sup>**

**Viasec Kosher Chips** 3 OZ. JAR **59<sup>¢</sup>**

**ICE CREAM** 1/2 GAL. CARTON **\$1.29**

**Fish Sticks** 10 OZ. PKG. **99<sup>¢</sup>**

**Bread Dough** PKG. OPI. 12 OZ. LOAVES **\$1.29**

**Birds Eye Tiny Taters** 10 OZ. PKG. **39<sup>¢</sup>**

**Birds Eye Chopped Spinach** 10 OZ. PKG. **5 for \$1.**

**Jeno's Haddock Dinner** 1 OZ. PKG. **49<sup>¢</sup>**

**Jeno's Deluxe Cheese Pizza** 3 OZ. PKG. **\$1.39**

**Birds Eye 100% Florida Orange Juice** 16 OZ. CAN **63<sup>¢</sup>**

**WALDBAUM'S DELICIOUS N.Y. STYLE DELI**

**BOILED HAM** DOMESTIC 1 L.B. **\$1.89**

**SLICING PROVOLONE** 1 L.B. **\$1.59**

**AMERICAN CHEESE** WHITE OR YELLOW 1 L.B. **\$1.29**

**LOX SALE** NOVA SCOTIA OR ALASKAN 1/2 L.B. **\$1.19**

**WHITE FISH** WHOLE OR HALF 1/2 L.B. **99<sup>¢</sup>**

**BEEF BOLOGNA** 1 L.B. **89<sup>¢</sup>**

**FRANKS** ROTHSCHILD NATURAL CASING 1 L.B. **\$1.39**

**ROAST BEEF** SLICED CARARADO 1/2 L.B. **79<sup>¢</sup>**

**GENOA SALAMI** CARARADO 1/2 L.B. **99<sup>¢</sup>**

**VEAL LOAF** CARARADO 1/2 L.B. **49<sup>¢</sup>**

**GEN LOAVES** PAP. LINSEED OLIVE. POLISH 1/2 L.B. **99<sup>¢</sup>**

**TUNA SALAD** 1/2 L.B. **69<sup>¢</sup>**

**"HOT" BAGELS** WHERE AVAILABLE **12 FOR 99<sup>¢</sup>**

**HEALTH & BEAUTY AIDS**

**J&K OFF LABEL - 7 OZ. BOTTLE Head & Shoulders** LOTION SHAMPOO **Your Choice 99<sup>¢</sup>**

**J&K OFF LABEL - 4 OZ. TUBE Head & Shoulders** CONCENTRATE SHAMPOO **99<sup>¢</sup>**

**J&K OFF LABEL - SCENTED OR UNSCENTED Sure Refreshant Deodorant** 0Z. **99<sup>¢</sup>**

**J&K OFF LABEL - 10 OZ. BOTTLE Scope Mouthwash** **99<sup>¢</sup>**

**IVORY LIQUID** 22 OZ. BOTTLE **69<sup>¢</sup>**

**JOY LIQUID** 32 OZ. BOTTLE **99<sup>¢</sup>**

**BAKERY**

**FOOD MART SLICED WHITE BREAD** 3 30 OZ. LOAVES **\$1.**

**FOOD MART - 11 OZ. PKG. 3 for \$1. English Muffins** 3 for \$1.

**GRANDINER Rye Bread** 15 OZ. LOAF **55<sup>¢</sup>**

**TIP TOP ST. LOUIS - 12 OZ. LOAF Rye Bread** 53<sup>¢</sup>

**GENEST Dessert Shells** PKG. OF 6 **63<sup>¢</sup>**

**GENEST Raisin Bread** 1 L.B. **69<sup>¢</sup>**

**HISHER'S Butter Top Bread** 30 OZ. **57<sup>¢</sup>**

**TOP FROST MEAT PIES** CHICKEN - BEEF OR TURKEY 5 OZ. PKG. **\$1.**

**EGGO WAFFLES** 55<sup>¢</sup>

**SARA LEE - 6 OZ. PKG. Macaroni & Cheese** 59<sup>¢</sup>

**NICH'S Chocolate Eclairs or Vanilla Cream Puffs** 8 1/2 PKG. **59<sup>¢</sup>**

### Museum To Have Plant Sale

A plant sale will be held at the Lutz Junior Museum, 126 Cedar St., Saturday and Sunday from 9 a.m. to 5 p.m. The sale is sponsored by the Volunteer League of the museum.

Plants of all descriptions including coleus, Swedish ivy, cacti and oxalis, will be available. All plants will be identified.

Any volunteer or anyone else wishing to donate plants may bring them to the museum Friday afternoon or Saturday morning.

Mrs. Edith Palmer and Mrs. Ruth Wilson will be the volunteers in charge of the sale. There are still openings available for the Peabody Museum/Arnold Arboretum field trip sponsored by the Lutz Junior Museum on May 10.

### Sterud Formally Received In Masonic District Post

Arne P. Sterud Tuesday night received his commission as a district deputy Grand Master for Connecticut Masons. The formal reception and investiture ceremony at the Masonic Temple was witnessed by more than 150 Masons from the local, area and state levels.

An unexpected guest who made an unannounced appearance, was R. Stanley Harrison of Bristol, Grand Master of Masons in Connecticut, who had appointed Sterud earlier this month during the Grand Lodge sessions.

Roger W. Aher, immediate past master of Manchester Lodge of Masons, was married as Sterud's associate grand marshal.

Right Worshipful Morris Budkofsky, grand junior deacon, conducted the ceremonies. Distinguished guests representing the several Masonic bodies of the state were received and recognized before the investiture.

Sterud and Aher were presented by Hayden W. Griswold Jr., the last district deputy from Manchester Lodge, he served in 1961-1963. Griswold offered a resume of Sterud's Masonic career.

### Spinning Your Wheels?

Getting things moving in our business. We take pride in our effective handling of real estate purchases, sales and leases. Call us at 646-4040 and get your deal moving.

**GORMAN**

Edward Gorman Agency  
Commercial and Industrial Real Estate Brokers  
Service Center Connecticut  
604 Middle Turnpike East  
Manchester, Connecticut

### Steel Profits Increase Despite Recession

RICHARD HUGHES UPI Business Writer

The nation's two largest steel companies Tuesday reported gains despite the deepening recession in the first three months of the year. But the profits of the largest auto-maker hit a 23-year low.

U.S. Steel Corp. and Bethlehem Steel Corp. said their first-quarter earnings were more than or nearly double profits in the same period last year.

Detroit did not fair as well. General Motors Corp. said its first quarter earnings fell 51 percent to \$59 million, or 20 cents a share, the lowest since losing \$38 million in a 1946 strike.

In the first three months of 1974, GM earned \$120 million or 41 cents a share.

U.S. Steel's first-quarter profits were \$162.1 million, or \$1.36 per share, compared to \$89.5 million, or \$1.65 per share, during the same period last year. Bethlehem's profits rose to \$80.3 million, or \$1.84 a share, compared to \$43.1 billion, or 99 cents a share. Despite the bleak first

quarter, GM executives joined officers of the two steel companies in expressing optimism about an end to the recession. GM Chairman Thomas A. Murphy and President Elliott M. Estes said "the pressures of inflation are easing, inventories are being reduced and shorter-term interest rates are lower."

Edgar R. Spear, chairman of U.S. Steel, and Lewis W. Foy, Bethlehem chairman, warned the steel companies are just beginning to feel the pinch of the recession, as customers cut back on orders.

But Spear said "We are optimistic that the worst of the economic recession is behind us, although a period of adjustment for the domestic steel industry still lies ahead."

In other developments Tuesday:

Business failures last week were the greatest in more than eight years. Dun & Bradstreet said. The firm said 313 commercial and industrial firms failed, the highest weekly total since March, 1967.

The new president of the American Bankers Association, J. Rex Duwe, said the price of single-family houses has risen faster than public's ability to buy because of inefficient use of materials and land by builders.

Inflation and recession are forcing dramatic changes in the life style of Americans, according to the annual report by General Mills on American Family Life. Americans are spending more time at home, giving fewer gifts, doing more home and auto repairs and using credit cards and charge accounts less, the study said.

### Oil Price Posting Bill Nearly Lost By Killian Absence

HARTFORD (UPI) — Lt. Gov. Robert K. Killian nearly missed his chance to give his old adversary, the oil industry, a little piece of mind suggested to be away from the Senate where he presides.

Opponents of a measure to require gasoline station operators to post their prices on conspicuous signs battled the measure to an 18-18 tie Tuesday while Killian was in his office after returning from a trip to New Milford.

Killian, who as attorney general accused 23 major oil companies of price fixing in violation of antitrust laws, made a speedy return to the upper chamber to salvage the situation.

Sen. James J. Murphy, D-North Franklin, having voted with the prevailing "nays" — who kept the bill short of the 19 yeas needed for passage — moved for reconsideration and won, 20-16.

The supporters were able to keep the proposal from sliding into legislative oblivion, 19-17, but had to settle for postponement of action on the measure.

**YOU WILL STOP SMOKING ON JUNE 4th**

At SmokeEnders, we will INSIST that you keep smoking until you have learned to quit easily, comfortably and with dignity — forever free of the desire to smoke.

We will teach you to quit smoking with NO severe tactics, NO willpower, withdrawal, NO shock treatment, NO drugs and NO "rold turkey" syndrome.

Enjoy the painless and popular SmokeEnders method that has received nationwide acclaim for being more happy, relaxed and stress-free than any other method.

SmokeEnders — totally indifferent to cigarette.

Yes! We'll assist to smoke. Right inflation by saving all that money. Come to a brief introductory meeting free. No fee. Please bring your cigarette — by June 4th you won't need them anymore.

**SMOKEENDERS®**

"THE EASY WAY TO QUIT SMOKING"

For information about meetings to other areas call or write 635 Pearl Street, Box 512, Northampton, Mass. 02727 (617) 345-8000 (413) 967-2221 (203) 732-1228. SmokeEnders, Inc., Phillipsburgh, N.J. 08865, 1975

**FLETCHER GLASS CO.** Over 25 Years of Experience

**Auto - Plate - Window Glass - Mirrors - Glass Furniture Tops - Picture Framing - Fireplace & Door Mirrors - Medicine Cabinets - Special Work**

Collectors' Items  
Danish Plates  
Franklin D. Roosevelt  
Decanters  
Nulline Reproductions  
Plastics in Stock  
1/2" - 3/16" - 1/8" Stock Sheets or Cut Sizes

**MANCHESTER DRUG**

717 MAIN STREET  
Phone 649-4541

**HNB MANCHESTER OFFICES**

Open Mon. through Fri. 9-3

DRIVE-IN HOURS 9-4  
**EVENING HOURS**  
Middle Turnpike Office  
320 Middle Turnpike West  
6-8 Thursday  
Manchester Green Office  
621 Middle Turnpike East  
6-8 Friday  
North Manchester Office  
220 North Main Street  
6-8 Wednesday  
First Manchester Office  
595 Main Street  
6-8 Thursday

We're with you all the way

**HARTFORD NATIONAL BANK & TRUST**

Solely Connected With Member FDIC

3 0

A P R

3 0

## Many Favor Further School Budget Cut

### SOUTH WINDSOR

JUDY KUEHNEL  
Correspondent

Nearly half the people attending the public hearing regarding the South Windsor Board of Education's 1975-76 budget, last night, voted in favor of slashing even more than the already proposed \$201,000.

In a straw vote taken at the conclusion of the hearing, nine persons voted in favor of adding back the \$201,000, 14 voted in favor of leaving the budget with the proposed cut, and 28 voted in favor of further slashing of funds toward education.

Board of Education member Marge Hutensky lashed out at those recommending budget cuts by saying that the proposed budget has "no fat."

"By cutting the budget you are making a mediocre system," said Mrs. Hutensky. "You don't like health education... well that's about athletics and home economics and music? We'll have none of these. This is a line item budget."

Unaware that the Town Council can only cut the budget and not dictate as to which areas they want deleted, some residents made an eleven-hour attempt at slashing both the current-year health education curriculum and the proposed additional assistant superintendent of schools.

The new assistant would cost the town \$23,000. One of the main functions of the assistant superintendent would be to evaluate teacher performance, seen by some as, "A luxury we can't afford."

The Human Development and Health Education curriculum for which funds have been appropriated has been under fire by a group of residents for some time.

Most residents in favor of budget slashes blamed the economy and asked councilmen to "Hold the back."

"My taxes have gone up 40 per cent since I moved here 18 years ago," complained one resident, "and my salary hasn't." Mayor Robert Smith said today that his main concern is holding the present tax line and he hopes that this can be done with no further budget cuts for education.

## Ideas Explored For Boosting Police Patrol

### COVENTRY

Stephan Fisher  
The Committee on Police Department met last night to determine how the town could solve its police manpower problem.

Committee members Robert Kjelquist, chief of police, Allen Sandberg, town manager, and councilmen Al Carilli and Henry Grabowski were primarily interested in how to place another patrolman on the now one-man third shift without drawing more money from the town budget.

All members agreed that the safety factor on the third shift is too low.

"I don't like shortening the manpower on any shift, but because of our budget I have to," said Kjelquist.

The present force of six patrolmen and one lieutenant allows for two policemen to be on duty on the first and second shifts but only leaves on patrolman for the third shift.

The committee proposed a number of alternatives, but none were accepted during the meeting as viable solutions.

Kjelquist said that he had applied for Federal funding in November. He said that if the funding is approved by the government that it would provide the money needed to buy and equip one patrol car and would also pay the salary for one additional policeman.

For the first year the funding would pay for 100 per cent of the costs for both man and car. The second year the funding would be reduced to 50 per cent of the patrolman's salary with no aid allotted for the maintenance of the car. The third year funding would allow only 25 per cent of the patrolman's salary. Kjelquist, however, was quick to point out that even though this would allow to place two men on each shift it still did not alleviate the problem of relief should one man become ill.

Councilman Carilli then suggested the use of supernumeraries to augment the force. Kjelquist dismissed the suggestion, saying that those men would be asked to work a 9-hour tour plus their full-time jobs. He also added that he doubted there would be very much response, and if used the plan could only be utilized on weekends and holidays.

Finally it was suggested that an intermittent shift be organized. Carilli said that this could be established by having one patrolman kept on stand-by during the 11 a.m. to 7 p.m. third shift. Kjelquist said that this plan might conflict with the union contract and would not alleviate the problem of overtime pay. He said that if a patrolman is called out on duty the contract demands that he be paid a minimum of 4 hours pay.

The committee decided to meet again on Monday for further discussion before going before the town council.

## Fire Study Group To Report Monday

### VERNON

The Vernon Fire Study Committee, appointed by Mayor Frank McCoy about a year ago, wrapped up its report Tuesday night and the report will be presented to the Town Council Monday, chairman Donald Eden said.

Similar requests were made last year and they were deleted at that time too. The study committee's charge was to make a thorough study of both departments as to equipment and housing and to report findings and recommendations back to the full council for action.

Monday's meeting will be at 7:30 p.m. in the administration building.

## Upholstery Shop Guttered by Fire

### VERNON

The interior of a one-story building housing Peter's Upholstery Shop on West Rd., Rockville, was gutted by fire shortly after 8:30 p.m. Wednesday.

The fire, of undetermined origin, destroyed furniture under repair and a quantity of upholstery materials and tools.

The business is owned by Peter Dow and is at the rear of a home on West Rd.

Fire Chief Donald Maguda said some of the firemen were given oxygen as an emergency measure. He said they did wear their Scott Air Paces while fighting the fire. No injuries were reported.

The Vernon Fire Department was on standby at the Nye Street fire station in Rockville and the Tolland Department was on standby at the Prospect Street fire station.

Chief Maguda said traffic was tied up at the busy intersection of West and Union Sts. Vernon Police were assisting by State troopers in rerouting traffic away from the fire scene.

The Rockville Department also responded to a brush fire at the fair grounds on Rt. 30, about 2 p.m. The Tolland Department also assisted.

Also during the day the department answered two calls to car fires, one in the parking lot of the redevelopment area in Rockville and the other at the intersection of West and W. Main Sts.

## Moore Named to Post In State Young GOP

### COVENTRY

Atty. Thomas Moore of Coventry has been appointed state membership chairman of the Connecticut Federation of Young Republicans.

Moore was recently elected chairman of the Coventry Young Republicans and is co-chairman of the Second North District Young Republican Organization.

He has been active in the Coventry Republican Town Committee and has served as chairman of its issues committee.

In his new position, Moore will assume primary responsibility for membership growth and development of Young Republican organizations throughout the state.

## AREA POLICE REPORT

### VERNON

Charles T. Surprenant, 23, of Connecticut Motel, Manchester, was arrested Wednesday on a warrant issued by Common Pleas Court in charging him with issuing a bad check.

Howard E. Johnson, 18, of Hartford, was charged early this morning with failure to obey traffic control signals, failure to obey an officer's signal, and operating under suspension.

Police said the incident started at the traffic light at the intersection of Center Rd. and Rt. 88 and Johnson failed to stop for the cruiser which was sounding the siren and flashing a red light. He was released on a \$250 non surety bond for appearance in court in Rockville on May 27.

NEW BUILDING TAKOMA PARK, Md. (UPI) - Seven-day Adventists have dedicated a new 10-story building, as part of their growing headquarters complex in the Washington, D.C. area.

Our Lady of Peace Mothers Circle will meet tonight at 8 at the home of Mrs. Joseph Sweeney, 83 Kennedy Rd. Mrs. Sobby Ghabrial is co-hostess.

A rummage and tag sale will be conducted Saturday from 9 a.m. to noon at the American Legion Post Home, Legion Dr. Donations may be left at the Post Home Friday. Those wishing to have donations shipped may contact Mrs. Clifford Walker, 76 Phelps Rd., 643-6155.

WESTERN BEEF  
63 TOLLAND TPKE. MANCHESTER, CONN. TEL. 643-1184  
MON., TUES., WED., SAT. 9-6  
THURS., FRI 9 to 9  
SUNDAY 9 to 6  
WE RESERVE THE RIGHT TO LIMIT QUANTITIES

MASTER CHARGE WELCOME ON FREEZER ORDERS

## WESTERN BEEF

63 TOLLAND TPKE. MANCHESTER, CONN. TEL. 643-1184  
MON., TUES., WED., SAT. 9-6  
THURS., FRI 9 to 9  
SUNDAY 9 to 6  
WE RESERVE THE RIGHT TO LIMIT QUANTITIES

OPEN SUNDAY 9-6  
SPECIALS THURS., FRI. AND SAT.

<b>BONELESS SHOULDER CLOD ROAST BEEF</b> 1.29 lb.	<b>CENTER CUT PORK CHOPS</b> 1.09 lb.
<b>WAYBEST WHOLE CHICKENS</b> 43¢ lb.	<b>TURKEY DRUMSTICKS</b> 39¢ lb.
<b>COUNTRY STYLE PORK RIBS</b> 89¢ lb.	<b>Bugnacki's Hot or Sweet ITALIAN SAUSAGE</b> 1.09 lb.
<b>SIRLOIN TIP ROAST BEEF</b> 1.39 lb.	<b>BOTTOM ROUND WITH EYE OF ROUND</b> 1.39 lb.
<b>SIRLOIN HIP OF BEEF</b> 1.39 lb.	<b>SHORT LOIN OF BEEF</b> 1.39 lb.
<b>OCEAN FRESH BOSTON BLUEFISH FILLETS</b> lb. 89¢	
<b>MAXWELL HOUSE COFFEE</b> 1 lb. CAN 89¢	<b>GOLD MEDAL FLOUR</b> 5 LB. BAG 79¢
<b>SWEET LIFE SODA</b> 48-oz. BU. 49¢	<b>WHOLE PORK LOINS</b> CUT AS DESIRED 99¢ lb.
<b>SWEET LIFE Jumbo White PAPER TOWELS</b> 2/89¢	<b>WHOLE HAMS</b> CUT AS DESIRED 89¢ lb.
<b>STARKIST CHUNK LIGHT TUNA</b> 6% OZ. CAN 55¢	<b>GROUND CHICK PATTIES</b> 99¢ lb.
<b>HINDS</b> 99¢	<b>SIDES</b> 89¢
1/2 Hinds & 1/2 Sides also available at this price. No Extra Charge for Cutting, Wrapping & Freezing.	

# YOU WON'T WANT TO MISS...

the terrific savings in our new Roto. If you did not receive your copy of the roto, please pick one up at your favorite Shop-Rite store.

## MEAT DEPARTMENT

<b>BEEF ROUND POT ROAST</b> \$1.07 lb.	<b>BEEF ROUND BOTTOM ROUND ROAST</b> \$1.17 lb.
<b>ROUNDER TIP ROAST</b> \$1.27 lb.	<b>BEEF CHUCK UNDER BLADE BONELESS POT ROAST</b> 97¢ lb.
<b>SLICED BEEF LIVER</b> 49¢ lb.	<b>BEEF ROUND, BONELESS BOTTOM ROUND RUMP ROAST</b> \$1.37 lb.
<b>WHOLE CHICKEN LEGS WITH RIB CAGE CHICKEN BREAST</b> 79¢ lb.	<b>SHOULDER STEAK</b> 89¢ lb.
BAKERY DEPT.!	
<b>CROWN TOP WHITE BREAD</b> 3 \$1	

<b>SHOP-RITE BREAD CRUMBS</b> 16-oz. can 39¢	<b>REG. OR LEMON-OUTAGON DISH DETERGENT</b> 48-oz. bot. 59¢
<b>SHOP-RITE MAYONNAISE</b> quart jar 89¢	<b>SHOP-RITE CREAMY OR CHUNKY PEANUT BUTTER</b> 40-oz. jar \$1.29
<b>SHOP-RITE FLOUR</b> 5-lb. bag 59¢	<b>VIVA ITALIAN 7 SEAS DRESSING</b> 16-oz. bot. 69¢
DELICATESSEN DEPT.	
<b>REG. OR THICK SHOP-RITE BACON</b> 1-lb. pkg. 99¢	<b>STORE SLICED IMPORTED BOILED HAM</b> 1/2-lb. 99¢
<b>BEEF OR REG. SWIFT FRANKS</b> 1-lb. pkg. 79¢	<b>STORE SLICED SHOP-RITE BOLOGNA</b> 99¢
<b>BEEF OR WEINER OSCAR MAYER FRANKS</b> 1-lb. pkg. 99¢	<b>STORE SLICED SHOP-RITE LIVERWURST</b> 99¢
<b>WHY PAY MORE? SHOP-RITE SAUERKRAUT</b> 1-lb. pkg. 29¢	<b>STORE SLICED TURKEY BREAST</b> 1/2-lb. 59¢
IN OUR DAIRY CASE!	
<b>TROPICANA ORANGE JUICE</b> 1/2-gal. 59¢	<b>WHY PAY MORE? SHOP-RITE MARGARINE</b> 1-lb. pkg. 39¢
<b>GOME THIN LITE COTTAGE CHEESE</b> 1-lb. pkg. 49¢	<b>BREAKSTONE'S TEMPTER WHIPPED CREAM CHEESE</b> 8-oz. pkg. 49¢
<b>FREZZER QUEEN ALL VARIETIES (EXCEPT BITE)</b> 2-lb. pkg. 89¢	<b>HOMESTYLE OR BUTTERMILK SHOP-RITE BISCUITS</b> 4-oz. pkg. 49¢

FARM FRESH PRODUCE!	
<b>U.S. #1 IDAHO BAKING POTATOES</b> 5 Lb. Bag 49¢	<b>TOMATOES</b> 3 Cans. 1.00
<b>DELICIOUS APPLES</b> RED OR GOLDEN 3 lbs. \$1	<b>PASCAL WHY PAY MORE? CELERY</b> 29¢
<b>CALIFORNIA ORANGES</b> #8 SIZE 10 for 99¢	<b>FLORIDA ORANGES</b> #100 SIZE 12 for 59¢
<b>587 EAST MIDDLE TURNPIKE MANCHESTER</b> Open 8:30 A.M.-1:30 P.M. Redeem Your Federal Food Stamps at Shop-Rite	

## Foreign News Commentary: Window on the World

By PHIL NEWSOM  
UPI Foreign News Analyst

Sino-Soviet Clash:  
The elimination of U.S. influence in Indochina will not create a power vacuum there but may lead to a confrontation of Soviet and Chinese influence in Cambodia and Vietnam.

New Energy Conference:  
France has not given up all hopes of playing host to a world energy and raw materials conference in spite of the collapse of a preparatory round of meetings in Paris by oil producing and consuming countries.

labor government to bring a new budget this summer with even tougher measures than those announced earlier in April. Chancellor of the Exchequer Denis Healey's appeal to the labor unions to hold back their pay hike demands has had little or no effect. On the contrary, many big unions are demanding not only 30 per cent pay hikes but an additional 10 to 15 per cent on top of that to make up for the higher taxes and living costs resulting from the Healey budget. Pay inflation in Britain now is rocketing up at a 32 per cent annual rate. Prices are surging up at a 21.5 per cent rate. The government is deeply concerned that foreign countries from which Britain has borrowed billions in the past two years to cover the oil-balance of payments deficit will pull out their money and refuse to lend. This would spark a major financial crisis and possible collapse of the pound.

The Rocket Abort:  
Soviet authorities have given a preliminary report to the United States on the failure of their last Soyuz launch, but little has emerged publicly about what caused the booster rocket to go wrong. What is known in Moscow is that the abort took place between 50 and 100 miles above the earth and the two cosmonauts landed in chest-high snow.

### Brown Professor Seeks To Harness World's Volcanoes

BY WARREN TALBOT

PROVIDENCE, R.I. (UPI)—There are approximately 600 active volcanoes on the earth. All are potential energy producers for an energy-starved planet.

The volcano release hot molten lava which otherwise would have been trapped deep beneath the earth's surface. Although nobody knows how many chambers of molten lava are underground, it is known they are potential energy producers.

Dr. John F. Hearnance, a Brown University associate professor of geological sciences, specializes in finding these chambers of lava which he calls the "ultimate sources of geothermal energy."

Energy from volcanoes and these hidden lava chambers are a very practical probability and will probably be done in the immediate future, in the next five to 10 years," Hearnance said.

Geothermal energy is best known in the forms of volcanoes, geysers and hot springs. Mankind already has tapped natural hot waters as an energy source, but volcanoes and lava remain little utilized.

Homes in Reykjavik, the capital of Iceland, have been heated for several years by natural hot water. Similar projects are under way in California, Mexico, New Zealand and other countries, Hearnance said.

"Extracting energy from these lava deposits has always been an intellectual goal of a stimulating idea. Rather than tell people where to drill, I specialize in finding these underground deposits," Hearnance said.

A research team at Sandia Laboratories in New Mexico is in research funds during the past five years to develop geothermal energy. Hearnance, who received his doctorate in physics from the University of Toronto, is getting ready for another trip to Iceland this year to further research the source.

"We chose Iceland to find answers because that country straddles an active tectonic area, a region of concentrated geologic activity," he said.

Extracting energy from the lava chambers and areas near volcanoes is not without its drawbacks. Drilling could result in the emission of noxious fumes.

"Sometimes we would have hot water we would not know what to do with and sometimes the ground around the drilling area would collapse," he said.

However, Hearnance says if modern science can send men to Mars, he believes it can develop ways to solve these "minor obstacles."

IT FIGURES  
NASSAU, Bahamas (UPI) — The Tongue of the Ocean, a massive human anatomy viewed from the air. The underwater natural phenomenon is over 100 miles long.

<b>Tropicana Orange Juice</b> 1/2 Gallon Carton 59¢	<b>Pillsbury 5 lb Flour</b> 5 lb. bag 69¢	<b>Maxwell House Coffee</b> 1 lb. can reg. drip or elect. perk. 79¢	<b>100 Lipton Tea Bags</b> 100 count box 89¢
<b>Potatoes Maine-U.S.No.1</b> 10 lb. bag 39¢	<b>Kraft Mayonnaise</b> 32 oz. jar 99¢	<b>Wheaties Cereal</b> 18 oz. box 59¢	<b>Free! Morton Salt</b> 26 oz. box Regular or Iodized
<b>Save 20¢ Mr. Muscle Oven Cleaner</b> 16 oz. can	<b>Save 20¢ Mrs. Filberts Margarine</b> Soft Spread Plug 4-8 oz. Bowls	<b>Save 50¢ Canada Dry Beverages</b> on 4-28 oz. no-return bottles assorted flavors	<b>Save 15¢ Assorted Donuts</b> Stop a Shop package of 12

## Your Stop & Shopsworth is 24 times better this week...save over \$7.00!

**Stop & Shop** SUPERMARKETS

24 extra-value coupons and a great canned ham special are just the beginning of what's good at Stop & Shop this week. Because every item here is a special value. Every item will save you money!

### Swift's Premium Week At Stop & Shop

The Swift's value guarantee quality and our special prices guarantee you save on all these delicious meats.

<b>3lb Canned Ham</b> \$3.79	<b>Save 30¢ Kool Aid</b> Assorted Flavors Makes 10 full quarts
<b>Ham Patties</b> Swift's Premium—21 oz. can \$1.59	<b>Save 20¢ Swift Premium Beef Franks</b> or Meat Franks
<b>Brown &amp; Serve Sausage</b> 8 oz. package 89¢	<b>Save 20¢ Swift Premium Bacon</b> Regular or Lazy Maple
<b>Smoked Pork Butt</b> Boneless Shoulder Water Added \$1.39 lb.	<b>Save 20¢ Stop &amp; Shop Cold Cuts</b> 1 pound package
<b>Ducklings</b> Delightful gourmet fare...serve with an orange sauce. 99¢	<b>Save 30¢ Beef Burgers</b> Stop & Shop 1 1/2 lb. package
<b>Corned Beef Brisket</b> for oven roasting \$1.59 lb.	<b>Save 20¢ Swift Premium Corned Beef Brisket</b>
<b>"Quality-Protected" Stop &amp; Shop Great Beef!</b>	
<b>Rib Steak</b> 1 lb. \$1.39	<b>Save 20¢ Aim Toothpaste</b> 6.4 oz. Tube
<b>Sliced Fresh In Our Service Deli</b>	<b>Save 20¢ Aim Ultra Ban Deodorant</b> Super Dry—8 oz. can
<b>Genoa Salami</b> 99¢	<b>Save 20¢ Aim Regular or Super Modess</b> 40 count pkg.
<b>Fresh Pizza</b> 89¢	<b>Get Your Hand Painted Stoneware... salad plate</b> 29¢
<b>Delicious Foods From Our Kitchen</b>	<b>Stop &amp; Shop Is Happy To Redeem Your Federal Food Coupons</b>



Michael Dworkin, president of the Parkade Merchants Association, presents \$200 worth of gift certificates to Mildred Gander of Andover, who won first prize in the Manchester Shopping Parkade's Spring Savings Spree contest last week. (Herald photo by Dunn)

### Parkade Stores Award \$1,000 Gift Certificates

Twenty-three entrants in last week's Manchester Shopping Parkade Spring Savings Spree are the winners of \$1,000 worth of gift certificates good at Parkade stores.

The winners, announced Tuesday, are:

First Prize (\$200 certificate) — Mildred Gander of Long Hill Rd., Andover.

Second Prize (\$100 certificate) — Art Johnson of 27 Walls Ave., East Hartford.

Third Prize (\$75 certificate) — Mrs. Shirley Pierce of 19 Ralph Rd., East Hartford.

Fourth Prize (\$50 certificate) — Marty Conderino of 459 Keeney St., Lois Ann Ryan of 20 Bates Rd., Mary T. Torrey of 153 Birch St., Frank E. Pierce Jr. of 610 Main St., South Windsor, and Mrs. Wilfred Paquette of 220 Avery St., South Windsor.

Fifth Prize (\$25 certificate each) — Beverly Plumb of 51 Dale Rd., G. M. Wu of Storrs; Jimmie Shelton of 173 Spruce St., Anne Cassidy of Lakewood Heights, Coventry; Jonathan Lange of 120 Meadow Lark Rd., Vernon.

Also, Robert Weiss of 61 Tumblebrook Dr., Vernon;

### BUSINESS

#### Big Board Gives Up Broker Price Fixing

NEW YORK (UPI) — Wall Street, the pride of capitalism, today reluctantly ends an 185-year era of price-fixing on brokerage commissions and hesitantly embraces free enterprise.

Under federal edict, brokers no longer will be able to establish uniform rates charged investors for buying and selling stocks. The fees, the government said, must be set in the open market. It will be the first time this free enterprise concept has applied since the New York Stock Exchange was founded in 1792.

#### 3M Appoints Local Outlet For Copiers

The Duplicating Products Division of the 3M Co., St. Paul, Minn., has appointed Marlow's Inc. of Main St., Manchester's exclusive dealer distributor of the 3M brand of copiers and THERMO-FAX brand of copy paper and supplies.

The popular priced dry desk copiers reproduce sharp black copies on white bond weight paper from letters, documents, bond books and magazines in all colors.

The equipment can be seen in Marlow's office equipment department.

Introductory Special! Buy a new Flip & Sew\* machine.

### Get Up To Double Our Usual Trade-In. \$50 At The Very Least!

Your choice of 3 new Flip & Sew machines, all with the exclusive Singer\* 2-way sewing surface. Flip a panel, sew in-the-round.

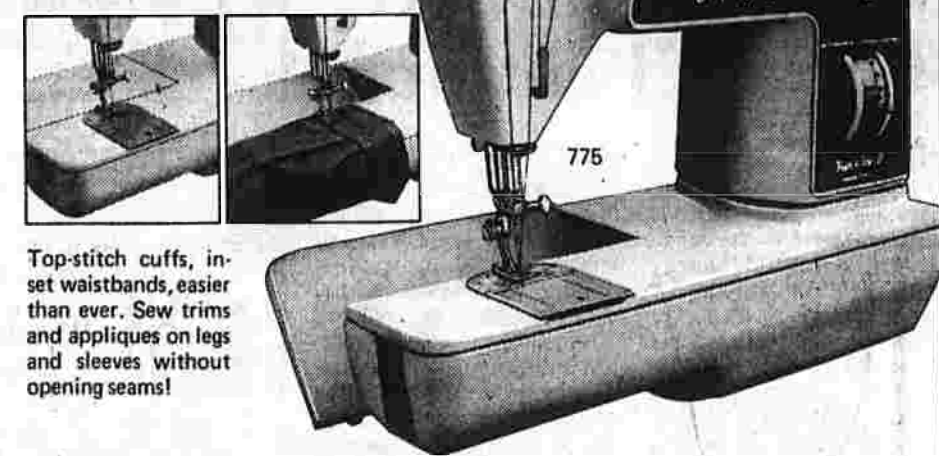

Top-stitch cuffs, inset waistbands, easier than ever. Sew trims and appliques on legs and sleeves without opening seams!

SAVE \$22.95 ZIG-ZAG MACHINE Carrying case or cabinet extra. Model 252/242. Sale \$97.95.

SALE! 1/3 OFF SELECTED DECORATOR CABINETS Reg. \$100 to \$180 NOW \$66.67 to \$120.

**SINGER** Sewing Centers and participating Approved Dealers.

### Nuclear Plant Security Termed Very Vulnerable

WASHINGTON (UPI) — An independent study of nuclear power plant safety has found that a determined band of terrorists equipped with the proper equipment and know-how could sabotage a power reactor and cause great loss of life.

"We found that by getting very detailed knowledge of the way the plant was laid out, much of that knowledge being public because of the requirements of the Freedom of Information Act, that a combination of high explosives, fires, wire cutters and so on could cause events that would be very likely to lead to a core melt-down," said Dr. Theodore Taylor of the International Research and Technology Corp.

"How difficult it would be to do this we found unable to say in general because power plants differ in detail and we weren't able to say systematically through any power plant," Taylor said in presenting part of the 12-man study panel's results to the annual meeting of the American Physical Society.

"We see no way to estimate the probability that such acts might be attempted either for coercive or outright terrorist purposes, but it is possible to estimate credible ranges of possible damage in terms of fatalities," the report said.

"It is conceivable that a group of people might threaten or carry out sabotage of a nuclear power plant in such a way as to cause great damage and loss of life," the study group said.

A core melt down is the most serious type of accident that could strike a nuclear power plant, particularly if containment structures failed and large amounts of radioactive material escaped into the atmosphere. Such an accident is considered extremely unlikely.

But the panel said its study found that the health consequences of such a hypothetical disaster in an area of high population density are much greater than previously believed.

### BICENTENNIAL FACTS

The British West Indian islands did not ally themselves politically with the 13 colonies, although sympathetic gestures of supplies and arms for the Revolution were offered. The islands were much more vulnerable to police action by the Royal Navy than were the colonies. The World Almanac notes that, by the same token, the islands were more vulnerable to attack by the navies of hostile nations and were more dependent upon the mother country for protection.

### Congressmen May Probe Shadowy International Police Agency

DAVID E. ANDERSON WASHINGTON (UPI) — Interpol, the private international police organization, has a kind of "Mission Impossible" image — shadowy international police agents tracking down equally shadowy international gangs of criminals.

After years of existing in the twilight of public scrutiny, however, some members of Congress are beginning to ask the question "just exactly what is Interpol and what are its implications for a citizen's right to privacy?"

Much of the new controversy was sparked by charges brought by the National Commission on Law Enforcement and Social Justice, an arm of the Church of Scientology. The church, which some people consider a genuine religion and others believe is a racket, got entangled in the intelligence web of Interpol when a West German news reporter showed church members information the German police had received from Britain's Scotland Yard through Interpol.

The church officials believed the information was false and sought to correct the records and at the same time began being concerned about the easy worldwide dissemination of police and intelligence files.

The result was an extensive investigation by the commission into Interpol's structure and activities which resulted in a 200-page report on the police organization.

Among its charges are that Interpol was a willing part of the Nazi Gestapo during World War II and that it lied to Congress about the Nazi connection in order to receive U.S. financial support and access to American police files on all levels.

Sen. Joseph Montoya, D-N.M., has shown an interest in the church commission's report on the private police organization and has asked Treasury Secretary William Simon some hard questions about Interpol. He is expected to press Simon and other Treasury officials even further during hearings on Treasury funding at the end of the month.

The U.S. branch of Interpol is housed in the Treasury Department and the U.S. dues of \$140,000 are part of the Treasury Department appropriation.

According to the commission, some of the Nazi influence has been carried into the present and it charged that the group has dragged its feet on pursuing Nazi war criminals, even when they were wanted for other crimes, and in the international effort to bring a halt to skyjacking.

Among the issues Montoya and some other congressmen want to get into is the degree of access foreign governments might have to U.S. police and intelligence files.

Interpol has 120 members, including two Communist bloc nations, Romania and Yugoslavia, as well as a number of other militarily ruled nations such as Chile and Brazil.

### PUBLIC RECORDS

Administrator's Deeds  
 Florence C. Hayden, administrator of the estate of Jennie Cook Pitkin, to Robert F. Blanchard and Paul J. Rosenthal, property on Proctor Rd., \$6,900.  
 Florence C. Hayden, administrator of the estate of Jennie Cook Pitkin, to Donald F. Jackson, property at 20 Proctor Rd., \$31,900.

Warranty Deeds  
 Donald F. Jackson to Wayne F. and Theresa L. Rauberberg, property at 20 Proctor Rd., \$33,500.  
 William J. Maher Jr. and Adeline M. Maher to Richard A. and Constance M. Thibodeau, unit in Northfield Green Condominium, \$30,500.  
 George E. and Elizabeth B. Coleman to Richard E. Merritt and Anne K. Miller, property on Kensington St., \$37,500.  
 Peter R. Zerjo to George E. and Elizabeth B. Coleman, property off Woodland St., \$37,200.

Federal Tax Lien  
 Internal Revenue Service against Winhall K. Jacobs, 72 Milford Rd., \$21,16.

Marriage Licenses  
 Michael George Gimmartino, Wethersfield, and Jane Lynn Wentland, 22 Meekville Rd., May 17, St. Bridget Church.  
 Thomas Douglass Marston, 129 Silver Lane, and Deborah Carla McCarthy, 15 Glenwood St., May 24, Wickham Park.

Building Permits  
 Empire Roofing for R.H. Ogren, alterations at 55 Vernon St., \$65.  
 Leon Cieszyński for Thomas Magnotta, additions at 32 Marshall Rd., \$3,200.  
 Suburban Home Improvement for Alexander Dawson, add garage at 97 Battista Rd., \$3,100.  
 Gordon Eagleson, swimming pool at 172 Porter St., \$200.  
 Anchor Fence Co. for Frank Styger, fence at 166 Vernon St., \$19.  
 Lawrence M. Smith, swimming pool at 36 Porter St., \$900.  
 Robert J. Carter, swimming pool at 17 Lucian St., \$400.  
 H. Hubbard, alterations at 211 High St., \$200.  
 Richard S. Burnett for Laszlo Szarka, alterations at 85-87 Birch St., \$1,800.  
 A Kingsbury Co. for Frank Traygas, alterations at 17 Green Rd., \$600.

## cumberland farms

# 1000<sup>th</sup> STORE CELEBRATION

THANKS TO YOU, cumberland farms ANNOUNCES ITS 1000<sup>th</sup> STORE OPENING WITH A MONTH LONG SALE FEATURING VALUES GALORE IN ALL OUR STORES FROM MAINE TO FLORIDA.

**ORANGE JUICE**

Large Grade A

**49¢** HALF GALLON

**EGGS**

Large Grade A

**59¢** DOZEN

**BACON**

Top O' The Morning

**\$1.15** POUND

**FUDGE BARS**

12 PACK **59¢**

**FIRST WEEK MONDAY APRIL 28 thru SUNDAY MAY 4**

WE RESERVE THE RIGHT TO LIMIT QUANTITIES

**ICE CREAM FLAVOR OF THE MONTH BUTTERSCOTCH WHIRL**

99¢ HALF GALLON

**BREAD 3 ONE POUND LOAVES**

99¢

**FRANKS**

all beef or extra mild

89¢ POUND

**NEWPORT CLUB SODA**

ASSORTED FLAVORS

3 28 oz. BOTTLES **89¢**

**VARIETY PACK**

SUSAGE PICKLE LOAF COOKED SALAMI BOLOGNA 12 oz.

**\$1.09**

**FRANKS**

all beef or extra mild

89¢ POUND

**Cottage Cheese** 16 oz.

**49¢**

**Yogurt**

SWISS STYLE

5 8 oz. CONTAINERS **99¢**

**Sour Cream**

16 oz. CONTAINER **39¢**

### Wedding Specialists

From arrangements for the first bridal party to the toss of the bouquet...

... we will strive to make your wedding as beautiful as you dreamed it would be. You can depend on us to add that special professional touch and advice for this important occasion in your life.

**Paul Buettner** FLORIST INC.

1122 Burnside Avenue, East Hartford, Connecticut Phone: 528-9585

### FOOD IS STILL A BARGAIN AT TOP NOTCH FOODS!

<b>TROPICANA Orange Juice</b> HALF GAL. <b>58¢</b>	<b>SUPER BUY! MARTINSON'S Coffee</b> 1-lb. CAN <b>88¢</b>	<b>HEINZ STRAINED Baby Food</b> 4 1/2 oz. JAR <b>10¢</b>	<b>SWEET LIFE SALAD DRESSING</b> QT. JAR <b>78¢</b>	<b>1-lb. CAN Chock Full O' Nuts COFFEE</b> <b>98¢</b>	<b>5 lb. BAG FLOUR</b> SWEET LIFE <b>59¢</b>	<b>2 lb. BOX Freezer Queen Entrees</b> All Varieties EXCEPT BEEF <b>88¢</b>	<b>SWEET LIFE 22 oz. Loaf WHITE BREAD</b> <b>31¢</b>
<b>OPEN 7 A.M. TO MIDNIGHT Mon. thru Sat.</b>		<b>BONELESS SIRLOIN TIP ROAST</b> lb. <b>1.24</b>		<b>3 LOIN 3 RIB COMBO PORK CHOPS</b> lb. <b>88¢</b>		<b>OPEN 7 A.M. TO MIDNIGHT Mon. thru Sat.</b>	
<b>TopNotch BIG DISCOUNT FOODS</b>		<b>FRESH No Backs Chicken Legs</b> lb. <b>68¢</b>		<b>CHUNK LIVERWURST</b> lb. <b>69¢</b>		<b>TopNotch BIG DISCOUNT FOODS</b>	
<b>GLASTONBURY FOR RUM MALL EAST HARTFORD 1150 BURNSIDE AVENUE 91 MANCHESTER 300 NORTH MAIN AT MAIN MEDFORD TOWN 200 WASHINGTON ST., RT. 56</b>		<b>FULL CUT SIRLOIN STEAK</b> lb. <b>1.18</b>		<b>FRESH CHICKEN BREASTS</b> NO WINGS lb. <b>88¢</b>		<b>PRICES EFFECTIVE THRU MAY 3, 1975</b>	
<b>BONELESS Chuck Roasts</b> lb. <b>94¢</b>		<b>PORTERHOUSE STEAKS</b> lb. <b>1.48</b>		<b>BREADED VEAL PATTIES</b> lb. <b>69¢</b>		<b>FRESH Ground Round</b> lb. <b>98¢</b>	
<b>FOR STEW OR SOUP PLATE BEEF</b> lb. <b>48¢</b>		<b>4 lb. Box FROZEN BEEF PATTIES</b> lb. <b>88¢</b>		<b>OSCAR MAYER FRANKS</b> ALL MEAT OR ALL BEEF lb. <b>98¢</b>		<b>PRIMO BRAND Hot or Sweet Italian Sausage</b> lb. <b>98¢</b>	
<b>BOTTOM Round Roasts</b> lb. <b>1.14</b>		<b>BEEF SHORT RIBS</b> lb. <b>68¢</b>		<b>ITALIAN BREADED VEAL PATTIES</b> lb. <b>69¢</b>		<b>Semi Boneless CHUCK ROASTS</b> lb. <b>78¢</b>	
<b>TOP OF THE CHUCK STEAKS</b> lb. <b>88¢</b>		<b>TOP ROUND ROAST</b> lb. <b>1.24</b>		<b>MUCKE'S Polish Rings</b> lb. <b>1.48</b>		<b>ELM BRAND PURE PORK SAUSAGE</b> lb. <b>1.08</b>	
<b>SEMI-BONELESS CALIF. CHUCK STEAK</b> lb. <b>78¢</b>		<b>SHOULDER London Broil</b> lb. <b>1.34</b>		<b>ARMOUR SMOKED SHOULDER</b> lb. <b>1.38</b>		<b>DAISY BUTTS</b> lb. <b>1.38</b>	
<b>SHORT CUT RIB STEAKS</b> lb. <b>1.18</b>		<b>CHUCK YANKEE POT ROAST</b> lb. <b>78¢</b>		<b>BONELESS TOP SIRLOIN STEAK</b> lb. <b>1.64</b>		<b>BONELESS TOP ROUND STEAK</b> lb. <b>1.64</b>	
<b>5 lb. CAN CUDAHY HAMS</b> <b>6.25</b>		<b>BONELESS FOR STEW BEEF CUBES</b> lb. <b>1.18</b>		<b>SLICED BEEF LIVER</b> lb. <b>48¢</b>			

NEWS CAPSULES

Exemption Sought - WASHINGTON (UPI) - Sen. Abraham A. Ribicoff, D-Conn., offered legislation today exempting state lotteries from a 2 percent tax on revenues and ticket-sellers from a \$500 occupational tax.

Model Rape Law Passed - CONCORD, N.H. (UPI) - New Hampshire's 400-member House with more women members than any time in history, has passed and sent to the Senate legislation ending a major obstacle to women reporting rape in this increasingly urban state.

Without opposition, the House Tuesday approved a bill locking a defense attorney from laying out a woman's past sexual history in a rape trial. The measure was modeled after Michigan law, drafted by the organization "Women Against Rape" and passed a year ago.

The bill faces uncertain action in the 24-member state Senate, where only two members are women. The 400-member House includes 106 women, the highest percentage of women in its history.

Superintendent Named - BOSTON (UPI) - Marion Fahy has been appointed superintendent of Boston's school system.

Capital Punishment Vetted - BOSTON (UPI) - Less than 30 minutes after it had been enacted, Gov. Michael S. Dukakis vetoed a new capital punishment law in Massachusetts. A check with Senate sources indicated the veto would be sustained with no votes to spare in the Senate. Dukakis, explaining his action, said he found it impossible to "reconcile the willful taking of a human life."

"Serious Miscalculation" - WASHINGTON (UPI) - Rep. Robert N. Giacomini, D-Conn., said America tried in trying to impose its foreign policy on the people of Vietnam.

Blast Kills Two - EAGLE PASS, TEX. (UPI) - A tank buried from an exploding butane truck crashed into a trailer park a half-mile away Tuesday, searing the residents with a 200-foot-high fireball that killed two persons and injured 45 others.

Quintuplets Named - CINCINNATI (UPI) - The proud parents of week-old quintuplets have finally arrived at five suitable names for their children.

When You Purchase... This MAGNIFICENT HOME ENTERTAINMENT CENTER

Prescription Drug Advertising Bill Sent to Governor

HARTFORD (UPI) - A number of bills are awaiting Gov. Ella Grasso's signature, including a measure expected to drive prescription drug prices down by allowing advertising.

The House Tuesday gave final approval to the drug bill that one group says could save the average Connecticut family \$180 a year by increasing competition among pharmacies and drug manufacturers.

Senators Approves Sperm Whale As State Animal - HARTFORD (UPI) - The Connecticut Senate has passed a bill designating the sperm whale its official state animal.

Unseaworthy Indicted - NEW YORK (UPI) - Anthony "Tony" Unseaworthy, the paunchy former New York City policeman, was indicted on charges of receiving a bribe to influence a measure of comic relief to the tedious Senate Watergate hearings with his tales of the whale tail.

It will be a serious miscalculation for our friends and potential adversaries to assume that the event in Vietnam that the United States has lost its national will," he said.

Small classes stressing individual instruction

Personal counseling on education and career plans

UNIVERSITY OF HARTFORD ADULT EDUCATIONAL ENRICHMENT PROGRAM Special Ten Week Pre-College Program May 27 through July 31

BUY NOW AND SAVE! CURTIS PORTABLE MATHS COLOR TV Reg. Price \$330 ONLY \$165

MEAT TOWN

1215 1/2 SILVER LANE • EAST HARTFORD Meat Economy Outlet

WAYBEST CHICKEN LEGS 46¢ Quarters

HAMBURG ROUND GROUND 67¢ 99¢

RIB ROAST OF BEEF \$1.29

GOLD CUTS HOT DOGS 39¢

HINDQUARTERS OF BEEF 89¢

Sirloin of Beef (SIRLOIN TIP) \$1.29

Fresh PORK LOIN COMBO 95¢

NOTICES

AUCTION - three cartons partitions, consigned to Norit Construction Co. 8 a.m. - May 1st, 150 Strong Rd. South Windsor.

INVITATION TO BID NOTICE - The Manchester Board of Education seeks bids for a Hiding Rotary Mower for the 1975-1976 school year.

NEWSPAPER DRIVER for six day delivery. Call Mr. Griffin at 647-9111.

NOTICE OF SALE - The following used equipment is offered for sale by sealed bid on May 20, 1975 at 11:00 A.M.

SHOP FOREMAN 2nd Shift - Supervisory experience, good background, 40 hour week, must have machining and set-up of aircraft parts.

LEGAL NOTICE - ZONING BOARD OF APPEALS - At an executive session of the Zoning Board of Appeals of Andover Conn. held on April 23, 1975 it was voted that the following variances to the Zoning Regulations be granted.

LEGAL NOTICE - WARNING & NOTICE OF MUNICIPAL ELECTION - TOWN OF BOLTON - MAY 5, 1975

Notice is hereby given that the Board of Directors, Town of Manchester, Connecticut, will hold a Public Hearing in the Hearing Room at the Municipal Building at Center Street, Manchester, Connecticut, Tuesday, May 6, 1975, at 8:00 P.M.

SECRETARY for property management and construction - General administrative responsibilities. Bookkeeping not required. Modern new office.

YOU UNEMPLOYED? ARE YOU ANSWERING AN ADVERT AD NOW WHAT?

The Herald

CLASSIFIED ADVERTISING PHONE 643-2711 FOR ASSISTANCE IN PLACING YOUR AD

HAPPY ADS SMILE TODAY

PLEASE READ YOUR AD

ADVERTISING DEADLINE

HELP WANTED

HELP WANTED

HELP WANTED

HELP WANTED

HELP WANTED

HELP WANTED

Real Estate

854,900 - Duplex, 6-3. Nice low priced, carpeting, 435 sq. ft. lot, 1 1/2 baths, fireplace, month income. Hutchins Agency, Realtors, 646-3166.

COVENTRY - 5 1/2 room Ranch. Garage, wall-to-wall carpeting. VA, no money down. \$129,900. Pask Realtors, 289-7475, 742-8243.

NEW ON Market - Quality built, Garrison Colonial, 4 bedrooms, plastered walls, 2 fireplaces, carpeting, pool and much more. \$54,800. Pask Realtors, 289-7475, 742-8243.

CONTEMPORARY Raised Ranch, one year old, large living room, with floor to ceiling stone fireplace. Beamed cathedral ceiling, ultra modern kitchen, 4 1/2 baths, formal dining room, photo room, 2-car garage, wooded lot, with a large deck. \$81,900. Pask Realtors, 646-4200.

WILL HOUSE clean one day a week. Call 643-2207 after 5 p.m.

PROFICIENT - telephone and computer office skills required for interesting part-time employment. Send reply to: Personel Dept, 2000, Vernon, Conn. 06066.

WANTED - experienced radiator repair, 40 hour week, in person to Olander's Body Shop, Route 5, Rockville, see Joe.

CUSTOMER SERVICE Manager - Typing ability and basic accounting background a must. For more information call 675-2548.

MULTIPLY OPERATOR PART-TIME - Applicant must have experience with a multiunit 1200-W. Hours are flexible on the day shift. For more information or to arrange for an interview, please contact the Personnel Department, 646-1222, ext. 45.

MANCHESTER MEMORIAL HOSPITAL - 711 Myrtle St., Manchester, Conn. An equal opportunity employer.

Real Estate

854,900 - 6 room Cape, shed dormer, 1 1/2 baths, fireplace, month income. Hutchins Agency, Realtors, 646-3166.

COVENTRY - 5 1/2 room Ranch. Garage, wall-to-wall carpeting. VA, no money down. \$129,900. Pask Realtors, 289-7475, 742-8243.

NEW ON Market - Quality built, Garrison Colonial, 4 bedrooms, plastered walls, 2 fireplaces, carpeting, pool and much more. \$54,800. Pask Realtors, 289-7475, 742-8243.

CONTEMPORARY Raised Ranch, one year old, large living room, with floor to ceiling stone fireplace. Beamed cathedral ceiling, ultra modern kitchen, 4 1/2 baths, formal dining room, photo room, 2-car garage, wooded lot, with a large deck. \$81,900. Pask Realtors, 646-4200.

WILL HOUSE clean one day a week. Call 643-2207 after 5 p.m.

PROFICIENT - telephone and computer office skills required for interesting part-time employment. Send reply to: Personel Dept, 2000, Vernon, Conn. 06066.

WANTED - experienced radiator repair, 40 hour week, in person to Olander's Body Shop, Route 5, Rockville, see Joe.

CUSTOMER SERVICE Manager - Typing ability and basic accounting background a must. For more information call 675-2548.

MULTIPLY OPERATOR PART-TIME - Applicant must have experience with a multiunit 1200-W. Hours are flexible on the day shift. For more information or to arrange for an interview, please contact the Personnel Department, 646-1222, ext. 45.

MANCHESTER MEMORIAL HOSPITAL - 711 Myrtle St., Manchester, Conn. An equal opportunity employer.

Real Estate

854,900 - 6 room Cape, shed dormer, 1 1/2 baths, fireplace, month income. Hutchins Agency, Realtors, 646-3166.

COVENTRY - 5 1/2 room Ranch. Garage, wall-to-wall carpeting. VA, no money down. \$129,900. Pask Realtors, 289-7475, 742-8243.

NEW ON Market - Quality built, Garrison Colonial, 4 bedrooms, plastered walls, 2 fireplaces, carpeting, pool and much more. \$54,800. Pask Realtors, 289-7475, 742-8243.

CONTEMPORARY Raised Ranch, one year old, large living room, with floor to ceiling stone fireplace. Beamed cathedral ceiling, ultra modern kitchen, 4 1/2 baths, formal dining room, photo room, 2-car garage, wooded lot, with a large deck. \$81,900. Pask Realtors, 646-4200.

WILL HOUSE clean one day a week. Call 643-2207 after 5 p.m.

PROFICIENT - telephone and computer office skills required for interesting part-time employment. Send reply to: Personel Dept, 2000, Vernon, Conn. 06066.

WANTED - experienced radiator repair, 40 hour week, in person to Olander's Body Shop, Route 5, Rockville, see Joe.

CUSTOMER SERVICE Manager - Typing ability and basic accounting background a must. For more information call 675-2548.

MULTIPLY OPERATOR PART-TIME - Applicant must have experience with a multiunit 1200-W. Hours are flexible on the day shift. For more information or to arrange for an interview, please contact the Personnel Department, 646-1222, ext. 45.

MANCHESTER MEMORIAL HOSPITAL - 711 Myrtle St., Manchester, Conn. An equal opportunity employer.

Real Estate

854,900 - 6 room Cape, shed dormer, 1 1/2 baths, fireplace, month income. Hutchins Agency, Realtors, 646-3166.

COVENTRY - 5 1/2 room Ranch. Garage, wall-to-wall carpeting. VA, no money down. \$129,900. Pask Realtors, 289-7475, 742-8243.

NEW ON Market - Quality built, Garrison Colonial, 4 bedrooms, plastered walls, 2 fireplaces, carpeting, pool and much more. \$54,800. Pask Realtors, 289-7475, 742-8243.

CONTEMPORARY Raised Ranch, one year old, large living room, with floor to ceiling stone fireplace. Beamed cathedral ceiling, ultra modern kitchen, 4 1/2 baths, formal dining room, photo room, 2-car garage, wooded lot, with a large deck. \$81,900. Pask Realtors, 646-4200.

WILL HOUSE clean one day a week. Call 643-2207 after 5 p.m.

PROFICIENT - telephone and computer office skills required for interesting part-time employment. Send reply to: Personel Dept, 2000, Vernon, Conn. 06066.

WANTED - experienced radiator repair, 40 hour week, in person to Olander's Body Shop, Route 5, Rockville, see Joe.

CUSTOMER SERVICE Manager - Typing ability and basic accounting background a must. For more information call 675-2548.

MULTIPLY OPERATOR PART-TIME - Applicant must have experience with a multiunit 1200-W. Hours are flexible on the day shift. For more information or to arrange for an interview, please contact the Personnel Department, 646-1222, ext. 45.

MANCHESTER MEMORIAL HOSPITAL - 711 Myrtle St., Manchester, Conn. An equal opportunity employer.

REALTOR'S CORNER 175 MAIN STREET PHONE 646-4025

**BENNY**  
BENNY, I REALIZE THAT THE DOCTOR TOLD YOU TO GET PLenty OF REST FOR YOUR COVR...

**BY JIM BERRY**  
...BUT THAT WAS SEVEN YEARS AGO!

**Homes For Sale** 23  
**Real Estate Wanted** 28  
**Painting-Papering** 32  
**Heating-Plumbing** 33

**L-RANCH** 7 spacious rooms, 3 bedrooms, fireplace, living room and family room, eat-in kitchen, 1/2 acre wooded lot, 1000 yards to private beach.  
**MERRITT** Realtors 645-1100

**Articles for Sale** 47  
**Apartment for Rent** 53  
**Business for Rent** 56  
**Autos for Sale** 61

**SHARE OFFICE space** with accountant. Excellent location for attorney, real estate, insurance, etc. 649-1500, 649-5549.

**Real Estate Wanted** 28  
**Painting-Papering** 32  
**Heating-Plumbing** 33

**INSTANT cash for your home.** Call Joe Gordon, Barrows & Wallace Co. Equal Housing Opportunity. 645-5306.

**Articles for Sale** 47  
**Apartment for Rent** 53  
**Business for Rent** 56  
**Autos for Sale** 61

**NEWER FOUR room Duplex.** 1 1/2 baths, kitchen appliances, \$215 per month. 645-2322, 644-8896.

**Real Estate Wanted** 28  
**Painting-Papering** 32  
**Heating-Plumbing** 33

**SHARPENING SERVICE - Saws, knives, axes, shears, skates, rotary blades.** Quick service. Capitol Equipment Co., 38 Main St., Manchester. Hours daily 7:30-5, Thursday 7:30-9, Saturday 7:30-4, 643-7858.

**Articles for Sale** 47  
**Apartment for Rent** 53  
**Business for Rent** 56  
**Autos for Sale** 61

**THREE Rooms - second floor.** Available May 1st. Includes heat, appliance, parking. No pets. Month security required. Call 645-2669 after 4.

**Real Estate Wanted** 28  
**Painting-Papering** 32  
**Heating-Plumbing** 33

**SHARPENING SERVICE - Saws, knives, axes, shears, skates, rotary blades.** Quick service. Capitol Equipment Co., 38 Main St., Manchester. Hours daily 7:30-5, Thursday 7:30-9, Saturday 7:30-4, 643-7858.

**Articles for Sale** 47  
**Apartment for Rent** 53  
**Business for Rent** 56  
**Autos for Sale** 61

**THREE Rooms - second floor.** Available May 1st. Includes heat, appliance, parking. No pets. Month security required. Call 645-2669 after 4.

**Real Estate Wanted** 28  
**Painting-Papering** 32  
**Heating-Plumbing** 33

**SHARPENING SERVICE - Saws, knives, axes, shears, skates, rotary blades.** Quick service. Capitol Equipment Co., 38 Main St., Manchester. Hours daily 7:30-5, Thursday 7:30-9, Saturday 7:30-4, 643-7858.

**Articles for Sale** 47  
**Apartment for Rent** 53  
**Business for Rent** 56  
**Autos for Sale** 61

**THREE Rooms - second floor.** Available May 1st. Includes heat, appliance, parking. No pets. Month security required. Call 645-2669 after 4.

**Real Estate Wanted** 28  
**Painting-Papering** 32  
**Heating-Plumbing** 33

**SHARPENING SERVICE - Saws, knives, axes, shears, skates, rotary blades.** Quick service. Capitol Equipment Co., 38 Main St., Manchester. Hours daily 7:30-5, Thursday 7:30-9, Saturday 7:30-4, 643-7858.

**Articles for Sale** 47  
**Apartment for Rent** 53  
**Business for Rent** 56  
**Autos for Sale** 61

**THREE Rooms - second floor.** Available May 1st. Includes heat, appliance, parking. No pets. Month security required. Call 645-2669 after 4.

**Real Estate Wanted** 28  
**Painting-Papering** 32  
**Heating-Plumbing** 33

**SHARPENING SERVICE - Saws, knives, axes, shears, skates, rotary blades.** Quick service. Capitol Equipment Co., 38 Main St., Manchester. Hours daily 7:30-5, Thursday 7:30-9, Saturday 7:30-4, 643-7858.

**Articles for Sale** 47  
**Apartment for Rent** 53  
**Business for Rent** 56  
**Autos for Sale** 61

**THREE Rooms - second floor.** Available May 1st. Includes heat, appliance, parking. No pets. Month security required. Call 645-2669 after 4.

**Real Estate Wanted** 28  
**Painting-Papering** 32  
**Heating-Plumbing** 33

**SHARPENING SERVICE - Saws, knives, axes, shears, skates, rotary blades.** Quick service. Capitol Equipment Co., 38 Main St., Manchester. Hours daily 7:30-5, Thursday 7:30-9, Saturday 7:30-4, 643-7858.

**Articles for Sale** 47  
**Apartment for Rent** 53  
**Business for Rent** 56  
**Autos for Sale** 61

**THREE Rooms - second floor.** Available May 1st. Includes heat, appliance, parking. No pets. Month security required. Call 645-2669 after 4.

**Real Estate Wanted** 28  
**Painting-Papering** 32  
**Heating-Plumbing** 33

**SHARPENING SERVICE - Saws, knives, axes, shears, skates, rotary blades.** Quick service. Capitol Equipment Co., 38 Main St., Manchester. Hours daily 7:30-5, Thursday 7:30-9, Saturday 7:30-4, 643-7858.

**Articles for Sale** 47  
**Apartment for Rent** 53  
**Business for Rent** 56  
**Autos for Sale** 61

**THREE Rooms - second floor.** Available May 1st. Includes heat, appliance, parking. No pets. Month security required. Call 645-2669 after 4.

**Real Estate Wanted** 28  
**Painting-Papering** 32  
**Heating-Plumbing** 33

**SHARPENING SERVICE - Saws, knives, axes, shears, skates, rotary blades.** Quick service. Capitol Equipment Co., 38 Main St., Manchester. Hours daily 7:30-5, Thursday 7:30-9, Saturday 7:30-4, 643-7858.

**Articles for Sale** 47  
**Apartment for Rent** 53  
**Business for Rent** 56  
**Autos for Sale** 61

**THREE Rooms - second floor.** Available May 1st. Includes heat, appliance, parking. No pets. Month security required. Call 645-2669 after 4.

**Real Estate Wanted** 28  
**Painting-Papering** 32  
**Heating-Plumbing** 33

**SHARPENING SERVICE - Saws, knives, axes, shears, skates, rotary blades.** Quick service. Capitol Equipment Co., 38 Main St., Manchester. Hours daily 7:30-5, Thursday 7:30-9, Saturday 7:30-4, 643-7858.

**Articles for Sale** 47  
**Apartment for Rent** 53  
**Business for Rent** 56  
**Autos for Sale** 61

**THREE Rooms - second floor.** Available May 1st. Includes heat, appliance, parking. No pets. Month security required. Call 645-2669 after 4.

**MICKEY FINN**  
I DON'T LIKE 'EM. I DON'T LIKE 'EM. I DON'T LIKE 'EM. I DON'T LIKE 'EM. I DON'T LIKE 'EM.

**OUT OUR WAY BY NED COCHRAN**  
TAKING A REST DAY. I'VE TAKEN A HANDFUL OF THE PIECES WITH ME. THE KIDS ALWAYS TRY TO BIAS ME BY FINISHING THESE THINGS WHEN I'M NOT AROUND - THIS TIME I'M GOING TO STOP 'EM COLDF.

**MUTT AND JEFF**  
NOW TO COMPLETE YOUR PHYSICAL EXAMINATION I WANT YOU TO LIFT THAT WEIGHT OVER YOUR HEAD!

**BUD FISHER**  
I WANT CRUMWELL THE GUY WHO'S WRITING ABOUT THE FLOWERS IN HIS POSTER. MAJOR - WHAT'S AN ECOLOGY PARTY? FREE ECOLOGY PARTY!

**PRISCILLA'S POP**  
I KNOW THAT SHE DIDN'T PUT HER FEET UNDER ME UNTIL SHE GOT TO GET HERE AS SOON AS POSSIBLE!

**DOC, ARE YOU O.K.?**  
YOU WANT I SHOULD CALL A DOCTOR?

**THE BORN LOSER**  
I'M... I'M SORRY, SIR, I JUST DON'T KNOW WHAT WENT WRONG... BELIEVE ME, I TRIED MY BEST IN THE WORST KIND OF WAY!

**WIN AT BRIDGE**  
MAKE IT ANOTHER MINERAL OR VEGETABLE. I CAN'T WIN AT BRIDGE.

**UP TO \$100 WANTED**  
WE WANT UP TO \$100 FOR YOUR JUNK CAR. Depending on Year and Mileage.

**WIN AT BRIDGE**  
MAKE IT ANOTHER MINERAL OR VEGETABLE. I CAN'T WIN AT BRIDGE.

**MR. ABERNATHY**  
MAYBE THIS NIGHT-LIGHT WOULD BE SUCH A GREAT IDEA.

**WIN AT BRIDGE**  
MAKE IT ANOTHER MINERAL OR VEGETABLE. I CAN'T WIN AT BRIDGE.

**BUZZ SAWYER**  
IF YOU'RE SURE SAM WAS ANSWERED, TRY TALK WITH BUZZ ABOUT IT.

**WIN AT BRIDGE**  
MAKE IT ANOTHER MINERAL OR VEGETABLE. I CAN'T WIN AT BRIDGE.

**BUZZ SAWYER**  
IF YOU'RE SURE SAM WAS ANSWERED, TRY TALK WITH BUZZ ABOUT IT.

**WIN AT BRIDGE**  
MAKE IT ANOTHER MINERAL OR VEGETABLE. I CAN'T WIN AT BRIDGE.



## STAMPS AND COINS

By RUSS MacKENDRICK

Anticipating the Bicentennial coins: Here is the quarter and the half.

The fronts have changed just the dating to read 1776-1976, but the reverses are something new. The half will show Independence Hall, an arc of 13 stars, "200 Years of Freedom," and the good old "E Pluribus Unum." (To you kids: It means One Out of Many.) The back of the quarter will have a real snappy Colonial drummer with a victory torch in a circle of stars and again E Pluribus. The coins will be of the usual size.

After July 4th — the deluge. The Mint, remembering the disappearance of the 1964 Kennedy's, will take no chances with hoarding.

The 15th Manpex at the MHS last weekend was just great. Mothers and fathers, sons and daughters, were all caught up with studying exhibits, filling album spaces at the bourse tables, bidding at the auction, or admiring the flags so generously displayed by Phil Daiguesault of Newington.

This production of the Manpex committee, led by the hardy perennial, Jerry Caron, went off like clockwork. And the two-day auction, about 200 lots, was called by Francois Gamache without a quaver in the decibel level throughout.

Vignette: At the setup, your eight exhibit pages are just tipped in at the lower edges onto a large cardboard and you approach the frame, make a bad move, and the sheets fall forward. Helping hands just appear from everywhere, there is a call: "Glass man!" and somebody comes carrying a heavy pane between wide-spread gloved hands, places it, another worker tightens the wooden strips, and your precious stamps are secure.

A new twist was the Saturday night dinner at Fiano's. The guest speaker, Frank Cignoli, director of the Hartford Sectional Center, handed out some encouraging cards detailing the USPS service standards that are already 69 per cent achieved. Club members are planning to visit the Hartford facility at his invitation.

A little early for Maine, but if you are headed up that way the show "Maipex '75 Falmouth" will be held May 17-18. The Maine Philatelic Society will offer a cover commemorating Benedict Arnold's expedition — Pittston, Me. to Quebec City in 1775 (before he fell from grace). A not to Maipex exhibitors: This Maine show is

## Congress Tackles Deficits

WASHINGTON (UPI) — Congress, accused over the years of running up deficits thoughtlessly, is giving thought this week to how large a deficit is tolerable at a time of recession and inflation.

Coming before both houses are resolutions proposing guidelines on spending and deficit totals for the fiscal year that starts July 1.

Both call for more spending and larger deficits than President Ford said are acceptable.

Both also propose shifts in how the money is spent — less for defense and foreign aid, more for helping recession victims and stimulating the economy with public jobs.

The debate is unusual. Congress rarely discusses such abstract questions.

Customarily, it has passed tax and spending bills without any thought to their impact either on the deficit or the economy. Not until a fiscal year had ended could the size of the deficit be known. Reform legislation, enacted in 1974, set up the new procedure.

Skepticism is high. Many in Congress doubt it can — or even wants to — change old patterns. Many came to Congress for the express purpose of channeling money into home districts.

As debate began Tuesday in the Senate and today in the House, here are the three proposals from the President and the House and Senate budget committees.

Revenue — Ford's proposal is \$295.6 billion; the House proposal \$295.0 billion, and the Senate \$297.8 billion.

Spending — Ford \$355.6 billion; House \$368.2 billion; Senate \$365.0 billion.

Deficit — Ford \$60.0 billion; House \$73.2 billion; Senate \$67.2 billion.

## Doctor Says Marriages Affected by Culture

"Marriage changes over the years dependent on the culture in which it exists."

This was one of Dr. John H. Houck's comments as he spoke to the Auxiliary of the Manchester Memorial Hospital Monday at its annual meeting at 9 e.h. mid 14th of "Love and Marriage" and said, as a psychiatrist, he is constantly impressed with the range and variety of experiences that come his way on the subject.

"In the Middle Ages, romantic love and marriage were not

considered the same. One could be married and have a great romance on the outside," he said.

He cited instances of exchange of love notes with someone other than the married mate, of troubadours and the like.

In Communist society, Dr. Houck said marriage and sex go together but love has little place. "It's considered very bourgeois."

"Our society today," he continued, "has idealized all three,

but it appears none of the three may go together."

He compared life today with when our country began.

"We were hedged in New England by Puritan tradition. Bundling was the result of the quality of life at the time," he said.

"Love," he said, comparing it to becoming acquainted through growing friendship, "is an even more complicated phenomenon."

"With love - we fall into, fall out of, make, give, lose, etc.," said Dr. Houck listing its complications.

The concept of one's marriage is according to the individual's early life experiences, he said.

"One tends to imitate the life patterns he grew up with. There are families to whom bickering is second nature, a way of life. There are others to whom it is unknown," he said.

Defining marriage, Dr. Houck said "Marriage is, in varying proportions, a religious, moral, social, economic contract between two people."

"For some, it is a casual relationship; for others, it is not to be nullified."

Divorced marriages are not new. But Dr. Houck said they are

"more open" and accepted than they used to be.

The difficulty with a trial marriage, said Dr. Houck, is that although it is a viable relationship, it is not the same as marriage. It is difficult to make a commitment.

He concluded his talk with

quotations from an essay on marriage, "Virginibus Puerisque," by Robert Louis Stevenson.

In effect, Stevenson and Dr. Houck seem to say there are marriages with and without love, and love with and without marriages.



open to all collectors — so send your brainchild further afield. (Contact Frank Morris, 9 Just-A-Mere Rd., Falmouth, ME 04105).

The charter membership deadline for the Connecticut Postal History Society has been extended to June 30. J. Richard Fay is the first president and Art Warmale is the vice. If you want to get in on the ground floor and receive the first issue of the Journal, write to V. Vaicsekuskas, Box 337, Wethersfield, Ct. 06109. Yearly dues: \$4.

The Paul Laurence Dunbar 10-cent stamp will have its first

day at Dayton, Ohio, tomorrow. It is the third in the American Art set. It will be in vertical format, five plate numbers. Our state of Connecticut, evidently a hot-bed of artistic talent, fostered the designer of this stamp, Walter Richards of New Canaan, who also did the Cape Hatteras foursome.

The CC Coin Club will meet Tuesday, May 6, at the K of C Home on Main St. The program will be a mini-seminar on counterfeits. There will be a setup of three microscopes together with some phony coins to examine and compare. Dealers' bourse, trading, and refreshments as usual.

## Bylaws Rejected

A new set of bylaws was voted down twice Monday by the Auxiliary of Manchester Memorial Hospital at its annual meeting at The Colony in Taicottville.

The auxiliary has drawn up new bylaws to replace the original ones which have been amended numerous times. Because many of the revisions were not completely understood by some of the members, the bylaws were not accepted.



The bylaws were rejected on the first vote of 95 affirmative and 65 negative. A two-thirds majority is necessary for passage of a vote.

After considerable discussion, another vote was taken. The count was 100 affirmative and 56 negative with several abstentions.

The next presentation of the bylaws for approval will be at the annual auxiliary meeting in April 1976.

## ABOUT TOWN

Manchester Lodge of Masons will pay a fraternal visit to Friendship Lodge of Masons at the Masonic Temple Thursday at 7:30 p.m. to perform the Fellowcraft degree.

A bicycle safety inspection will be sponsored by Cub Scout Pack 538 Saturday from 9 a.m.

to 3 p.m. at Robinson School parking lot. The inspection is open to the public.

Chapman Court, Order of Amaranth, will meet Friday at 7:45 p.m. at the Masonic Temple. Officers will wear white gowns and rehearse at 7 p.m.

**SPECIAL! ROYAL**  
All Electric Portable TYPEWRITER With Case, Plus A FREE \$49.95 CALCULATOR With Each Purchase! (Limited Supply)  
**YALE TYPEWRITER**  
41 Purnell Place  
Manchester • 649-4986

# youth is not wasted on the young...



Charge it  
CONVENIENT CHARGE PLANS AVAILABLE

We think it's great! And we think you'll find our selection of bedrooms for the young pretty great too! Choose from rugged **COLONIAL** designs in solid pine, or select a delicate **PROVINCIAL** design in soft pastels, painted finishes and "mar-proof" tops! Whatever you choose, you'll love it — and so will your children. Co-ordinated chests, desks, dressers, tables, chairs, mirrors, beds and headboards — all designed for **MAXIMUM** usability, function and longlasting durability.

Shown above is one of the newest designs in the classic "CAMPAIGN" style...with the added features of "pewter" hardware, rough sewn finish. Choose from a large selection of matching pieces that will make anyone young, or old, or in between almost excited about "going to their room."

	REG	SALE		REG.	SALE
Storage bed	308	260	3 Drwr chest	121	109
Shelf unit	121	109	Twin size panel bed	99	89
Bach. Chest, deck	159	143	Trundle bed	264	238
Dbl. Dresser	209	188	Student desk	170	153
Mirror	55	50	Corner desk	159	143
Nite stand	88	79			
5 Drawer chest	187	160			

During the month of APRIL, for every \$15 purchase, you will receive a new \$2 bill, REDEEMABLE towards additional merchandise on MAY 1, 2 & 3. PLUS! You may be one of the lucky couples to "DOUBLE their MONEY" during our special drawing on MAY 3rd.

WE CAN HELP



# Watkins

935 MAIN ST., MANCHESTER / 643-5171  
OPEN: TUE THROUGH FRI TIL 9 / SAT. TIL 5:30  
Closed Mon.

## At Pinehurst PERDUE CHICKEN!

# It's chicken-lickin' good!

After you sink your teeth into our tasty fresh PERDUE Chicken, you'll know what Chicken-Lickin' good is about...

We have daily shipments of Perdue Roasters, Fryers, Breasts and Legs. Chicken that's low in price, low in calories and high in nutritious protein.

It's good to see lower prices.

**meat-**  
**BUTTERBALL TURKEYS** **66¢** lb.  
11 to 16 lbs.

And smaller Butterballs, 7 to 10 lb. hens 69¢ lb.

## Pinehurst U.S. Choice Beef Sale

EYE ROUND OVEN BEEF ROAST \$1.85 lb.	BACK RUMP OR 3 CORNER OVEN BEEF ROAST \$1.59 lb.
BOTTOM ROUND POT ROAST \$1.29 lb.	BOTTOM ROUND CENTER ROAST OR SWISS SLICES \$1.49 lb.
U.S. CHOICE CUBE STEAK \$1.79 lb.	BITE SIZED BEEF STEW CUBES \$1.39 lb.

Frank Toros suggests these freezer pleasers...We wrap, freeze and have any cut ready for you.

Packer Cuts of Bottom Round with Eye \$1.44 lb., Bottoms without Eye, \$1.35 lb. Whole 12 to 14 lb. Sirloin Tips, \$14.9 lb. and Whole U.S. Choice Tenderloins at \$2.89 lb.

Ed Fontana says we have the leanest Boneless Brisket Corned Beef that it is possible to get. To see it is to buy it...We always have a sellout on his lean Brisket. Whole Brisket or Thick End at \$1.29 lb. Strictly Center Cuts at \$1.89 lb.

## FRESH FLOUNDER...HADDOCK...SCALLOPS

Lower sugar prices have brought prices down on Coke, Pepsi and now we feature Full Quarts of COTT GINGER ALE and CLUB SODA at a very low price. Save 20¢ on Ale and Club when you buy it on this sale at...

# 2 QTS. 79¢

or buy it in straight case lots of 12 qts. Club or 12 qts. Ginger Ale at 3 qts. \$1.00...CASE OF 12 \*4.00.

## SPEND LESS, Learn to Shop PINEHURST

With Any Other \$10.00 Purchase  
**JACK FROST GRANULATED SUGAR**  
**\$1.79** 5 lb. bag

LAND OF LAKES CHEESE 5 lb. Box \$4.99	SHURFINE FRUIT COCKTAIL 59¢ 2 1/2 can
MARTINSON'S FINE COFFEE \$1.00 lb.	FAMILY PACK CORONET BATH TISSUE \$1.39 8 Rolls

Save on deal Pack "Cents Off" Jumbo Detergents 50¢ Off on Dial and Bold. 60¢ Off on Dash and 30¢ Off Jumbo All.

With any other \$7.50 Purchase Buy **LAND OF LAKES BUTTER** at Pinehurst for only **79¢** lb.  
**PIZZA PANS \$1.05**  
**CUP CAKE PANS 89¢**  
Reg. \$1.40 Rubber Made **DUST PANS SPECIAL \$1.09**

Shop Pinehurst Thurs. and Fri 8 A.M. til 8 P.M.; Sat. 8 A.M. til 6 P.M. and Sunday 8 A.M. til 2:00 P.M.

**PINEHURST GROCERY INC.**  
North of the Armory at 302 Main

od!

fresh PERDUE

ckin' good is

sters, Fryers,

price, low in

r prices.

eat-

6¢ lb.

to 16 lbs.

hens 69¢ lb.

of Sale

UMP OR 3  
ER OVEN  
ROAST

59 lb.

M ROUND  
R ROAST  
SS SLICES

49 lb.

IZED BEEF  
CUBES

39 lb.

pleasers...We

you.

Eye \$1.44 lb.,

12 to 14 lb.

U.S. Choice

est Boneless

get. To see it

on his lean

.29 lb. Strictly

SCALLOPS

ices down on

arts of COTT

ry low price.

it on this sale

Club or 12 qts.

12 \$4.00.

PINEHURST

hase

ATED

INE FRUIT

KTAIL

2 1/2 can

ACK CORONET

TISSUE

39 8 Rolls

bo Detergents

Dash and 30¢

\$1.05

PANS 89¢

Rubber Made

ST PANS

IAL \$1.09

Fri 8 A.M.

6 P.M.

00 P.M.

# CALDOR Mother's Day GIFT IDEAS

Sale Now Thru  
Sat., May 3rd



**G.E.  
Lighted  
Dial  
Snooze-  
Alarm Clock**  
4.77 Our Regular 8.79

View alarm tells if alarm is set... repeats its signal to let you nap. Attractive sandalwood case. #7270K



**Concepts 1000  
Blower-Styler**  
Our Regular 13.99  
9.87 SAVE \$4!

Super drying 1,000 watt power; low and high drying and styling speeds. Spot drying nozzle. #C1000



**Shower Massage  
by  
Water Pik®**  
Our Regular 22.99  
17.76

Unique massaging action stimulates circulation. Enjoy a massage with every shower! #SM2  
Deluxe, Reg. 36.99... 26.76

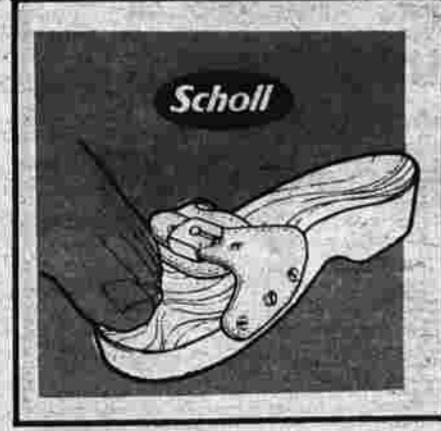

**Scholl's  
Exercise Sandals**  
Our Reg. 10.88  
8.88

Better than barefoot! Choose from assorted colors and sizes.

## Spring Sportswear

\$5 each

YOUR CHOICE  
Our Regular  
Up To 7.99

**Cardigans**

100% Wintuck®  
pointelle stitch, sizes 34 to 40.

**Long Sleeved Shirts**

Silky acetate and nylon  
prints, 32 to 38.

**Short Sleeved Twin  
Sets**

Nylon halter twins  
and jacquards, S-M-L.

**Pants**

Knit pants, ultra  
smart, 8 to 16.

**Scoters**

Woven or knit,  
panel and  
wrap styles,  
8-16.

## Sleepwear

Our Reg. 2.99 to 7.99

2.37 TO 6.34

Tailored Pjs, graceful long  
and waltz gowns, pert baby  
dolls in fluttery, feminine  
fabrics.

## Tops 'n' Shorts

YOUR CHOICE  
Our Regular  
Up To 4.99

2.99 each

TOPS: Shells, mock, full  
turtle, jewel necks... short  
sleeve shirts and knit tops,  
many colors, all S-M-L.

SHORTS: Fly front, jean  
style in solids or pullon  
in prints, sizes 8 to 16.







**Caldor's Amplon® Pantyhose**  
Reg. 2 for 1.59  
**2 for \$1**  
All nude sheer or reinforced top.

**Sheer Agilon® Pantyhose**  
Reg. 1.59  
**84¢**  
Super sheer in 4 sizes.

**Control Top Pantyhose**  
Reg. 1.59  
**84¢**  
Light tummy control, sheer leg.

**Sheer Knee-Hi Hose**  
**4 Pair \$1 Pkg.**  
Elastic cuff, many colors.



**Women's Terry Moc Slippers**  
Reg. 3.29  
**2 77**  
Cushion crepe sole; 5-10.



**Brief & Bikini Panties**  
Reg. to 89c  
**3 for 1 44**  
Strings, hip huggers, etc.



**Stretch Strap Bras**  
Reg. 1.99  
**1 59**  
Many styles 32-40, A-B-C.



**Famous Maker Sleeveless & Short Sleeve Body Suits**  
Reg. 3.88  
**\$2**  
Casual or dressy styles in solids or prints.



**Foot Flattering Sandals Your Choice**  
Reg. 4.99  
**3 87** Ea.  
Ideal go-with-everything sandals, made in Italy. Also rope bottoms, flats, heels.



**Spring Handbags**  
Reg. to 7.99 ..... Reg. to 13.99  
**\$ 5 ..... \$ 9**

Beautiful leathers, versatile vinyls, up and coming canvas! Fashions to please everyone—dressy or casual. Colors galore.



**Ladies' & Men's Nylon Umbrellas**  
Reg. to 5.99  
**4 40**  
Many styles, world-wide imports.

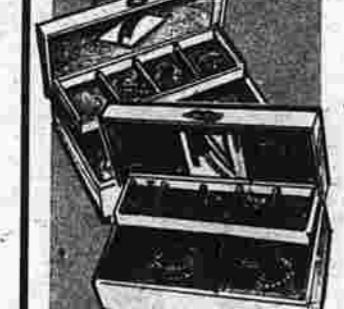

**Ladies' Jewel Boxes**  
Reg. to 11.99  
**\$ 7**  
Many styles, some music boxes!



**Ladies' Spring Hats**  
Reg. to 2.99  
**2 99**  
Every imaginable pretty style!



**Ladies' Fashion Belts**  
Reg. to 2.99  
**2 99**  
Ropes, 1 to 1½" wide, leather trimmed, buckled, tabbed.

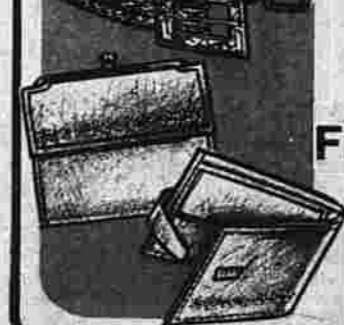

**Ladies' Leather Billfolds & French Purses**  
Reg. to 6.99  
**4 99** Ea.  
Bright colors, classic styles or daisy motif; elegant hardware.

Lingerie Dept. Not at Riverside



**20% OFF Ladies' Smocks, Shifts, Robes & Loungewear**  
Reg. 4.99 to 14.99  
**3 99 to 11 99**

A heavenly collection of loungewear in permanent press cottons and blends, gossamer sheer nylon and nylon blends... solid colors and pretty prints.



**Misses' & Women's Polyester Pantsuits**  
Our Reg. 11.99  
**8 77**

Solids, embroidery or nailhead trimmed, many with white poly pants. Prints and jacquards in your favorite colors. 10 to 18 & 14½ to 22½.



**Misses' & Women's Daytime Dresses**  
Our Reg. 8.99  
**6 57**

Fashions for everyone! Zip fronts, halters, jewel necks... solids, jacquards and combos. Navy, Mint, White, Melon. 10 to 18 & 14½ to 22½.



**Misses' or Juniors' Nylon Jackets**  
Our Reg. 4.99  
**3 88**

Cire bike jackets; pant coats, all smartly detailed; contrast stitching. Navy, White, Red, Blue, Black. S, M, L.



**Misses' Polyester Blazers**  
Our Reg. 8.99  
**\$ 7**

Notched or peak lapels, single-breasted. Textured surface: White, Navy, Red; 8 to 16.



**Misses' Spring Outerwear**  
Reg. 14.99 to 19.99  
**\$10 & \$15**

Poly/cotton oxford or Dacron®/cotton blends; some crushed vinyl. Fashion's newest details, many colors. Jr. and miss sizes. 8 to 16 & 5 to 15.

Ladies' Apparel Not at Riverside



**100% Polyester Separates**  
At Fantastic Savings...

**Pants** Reg. 6.99 **4 88**  
**Print Shirts** Reg. 7.99 **5 88**  
**Shirt Jacs** Reg. 8.99 **6 88**

The epitome of "New for Spring"! Classic casuals, outstanding anywhere. Delicious colors, sizes 8 to 18.

**Boys' Warm-Up Jackets**  
Reg. 5.99  
**4<sup>37</sup>**

Flannel lined nylon shell, 2 front pockets. 8 to 18, machine wash.

100% Washable  
**Cotton Pocket T-Shirts**  
Reg. 1.69  
**1<sup>27</sup>**

Short sleeves for Spring days! Solid colors, sizes S, M, L.

100% Cotton  
**Denim Jeans**  
Reg. 5.99  
**4<sup>77</sup>**

Popular western style in machine washable denim. Reg. sizes 8-18, slims 8 to 16.

**Men's Long Sleeve Qiana Sport Shirts**  
Reg. 9.99  
**7<sup>44</sup>**

Du Pont's elegant Qiana fabric in many dark and light shades; S to XL.

**Poplin Casual Slacks**  
Reg. 8.99  
**\$7**

Buy Several

Crisp, cool Summer slacks of permanent press poly/cotton, with redi-hems. New light shades, 32-42.

**Men's Short Sleeve Dress Shirts**  
Reg. 3.99  
**\$3**

Large Selection

Never iron 65% polyester, 35% cotton. Well tailored in smart pastels and medium shades; 14 1/2-17.

**Waist Watcher Doubleknit Slacks**  
Reg. 12.99  
**\$9**

Fantastic Value!

Sensational slacks that really hold tummy in! Flare legs, great Spring solids, 30 to 42.

**BABY Sale!**

**PAMPERS**  
Overnight Newborn  
Reg. 1.15 **99c** Reg. 1.95 **1<sup>59</sup>**

Handy tapes, no pins. Limit 6 boxes per customer, No Rain Checks.

**Infants' & Toddlers' Spring Non-Flammable Sleepwear**  
Reg. 2.99 **2<sup>27</sup>**

Pajamas, 1 and 2 piece sleepers for boys and girls. Sizes 1 to 4, 9 to 18 mos.

**Infants' & Toddlers' Fun 'N Sunwear**  
Reg. 1.99 **1<sup>38</sup>**

Bubble suits for girls, shortalls for boys. M to XL and 2 to 4.

**Girls' Smart Spring Co-Ordinates**

Shirt Reg. 3.99	Slacks Reg. 4.99	Jacket Reg. 6.99
--------------------	---------------------	---------------------

**2<sup>77</sup> 3<sup>77</sup> 4<sup>77</sup>**

Zingy embroidered knit shirts, plus zip-fly, belt looped slacks, topped with pretty jacket! Add them together and get the look of Spring! Sizes 7 to 14.

**Girls' New Spring Print Blouses**  
Reg. 3.99 **2<sup>87</sup>**

Peasant or smock styles are naturals over jeans or slacks. Machine wash; 4 to 12.

**Girls' Fashion Slacks or Jeans**  
Reg. to 6.99 **4<sup>87</sup>**

Solids, checks in pastel solid knits, denim or twill. Suspender styles, too; 4 to 14.

**FABRIC SALE**  
New Selection  
Top Mills!  
**POLYESTER DOUBLEKNITS Solids & Fancies**  
Reg. to 3.99 **Your Choice 1<sup>99</sup>** Yd.

New designs, colors, stitches! Machine wash/dry; 60" wide.

**Broadcloth Prints**  
Perma-press, 65% poly, 35% cotton. Great selection; 45" wide.  
Reg. 99c Yd. **84c** Yd.

**Gingham Checks**  
65% Dacron® poly, 35% cotton. Machine wash/dry, 45" wide.  
Reg. 1.69 Yd. **99c** Yd.

**Jersey Prints**  
Nylon/acetate, hand wash. Wrinkle free, 45-52" wide.  
Reg. 1.99 Yd. **1<sup>57</sup>** Yd.

**Sportswear & Novelty Prints**  
Famous Name Cotton and blends, 49" wide. Great selection! Mach. wash.  
**1<sup>97</sup>** Yd.

**Dacron® Polyester Gabardine**  
Famous Name For sports, menswear, etc. Machine wash, 60" wide.  
Reg. 4.49 Yd. **3<sup>17</sup>** Yd.

**Boys' Solids & Stripes Tank Tops**  
4 to 7  
Reg. 1.99 **1<sup>67</sup>**  
S, M & L  
Reg. 2.59 **1<sup>87</sup>**

Trimmed with contrasting piping; machine washable.

**Western Style Frayed Shorts**  
4 to 7  
Reg. 2.99 **2<sup>27</sup>**  
8 to 16  
Reg. 3.99 **2<sup>97</sup>**

Cotton or poly/cotton blends, machine washable.

**Men's Terry Crew Shirts**  
Reg. 2.99 **2<sup>37</sup>**

80% cotton, 20% nylon blend, solids or stripes, sizes S to XL.

**Men's & Young Men's Famous Label Jeans**  
Reg. to 8.99 **\$7**

Navy and colors, 4 or 5 patch pocket styles; sizes 29 to 42.

**Men's Cool Mesh Short Sleeve Sport Shirts**  
Reg. 5.99 **4<sup>44</sup>**

Poly/cotton mesh knits in terrific pastels! Sizes S to XL.

**Walk Shorts**  
Reg. 4.99 **3<sup>87</sup>**

Solids, plaids, checks in smart poplin; sizes 32 to 42.

**Girls' Nylon Hooded Water-Repellent Jackets**  
Reg. 3.99 **2<sup>99</sup>**

Nylon shell with flannel lining; fashion colors. Sizes 7 to 10.

**Now thru Summer Girls' Pretty Short Sets**  
Reg. to 3.49 **2<sup>33</sup>**

Crisp, fresh Spring fabrics of polyester, nylon, or denim. Screen prints, jacquards, or solids; 4 to 14.

**Coronation Yarn of Creslan® Acrylic**  
Reg. 79c Skein **59c** Skein

Our best selling yarn! Machine wash and dry. 4 oz., 4-ply.; many colors.

**Boys' Swim Wear**  
4 to 7  
Reg. 2.69 **1<sup>87</sup>**  
S, M, L  
Reg. 2.99 **2<sup>67</sup>**

Basketball or knit styles; solids and fancies, many colors.

**Men's Camp Moccasins**  
Reg. 6.99 **5<sup>70</sup>**

Real leather uppers with rugged rawhide laces; comfortable with or without socks. Sizes 6 1/2 to 12.

**Men's Poplin Golf Jackets**  
Reg. 7.99 **\$6**

Poly/cotton shell, 26" long; nylon mesh inside yoke. Perma-press; S to XL.

**Exciting New Aztec Wedges**  
Our Reg. 6.99 **5<sup>88</sup>**

Multi-colored uppers; Rope covered wedges. Sizes 5 to 10.

**All Purpose Athletic Shoes CAL-PRO**  
Introductory Special... **\$6** Buy Several Pair!

After Sale 8.77  
**Save Over 30%**

Boy's sizes 2 1/2 to 6, Men's 6 1/2 to 12

**20% OFF**  
ENTIRE STOCK OF  
**Art NEEDLEWORK**

- Crewel
- Needlepoint
- Cross Stitch
- Stamped Goods

# Super Savings during Caldor's

## Malimo Decorative Draw Draperies

SINGLE WINDOW	DOUBLE WINDOW	TRIPLE WINDOW
Our Reg. 11.99 <b>6.94</b> 48"x63" 48"x84", Our Reg. 12.99 8.97	Our Reg. 30.99 <b>19.40</b> 96"x84"	Our Reg. 45.99 <b>29.70</b> 144"x84"

Fashionable, airy open weave drapes in marvelous shades of Gold, Rust, Willow or Olive. Machine wash, permanent press.

## Airy Open Knit Tailored Panels

Our Reg. 2.29 <b>3.87</b> 63"	Our Reg. 6.29 <b>4.97</b> 81"
----------------------------------	----------------------------------

Snowy white, open weave panels of 100% polyester. Generous 5" bottom hem, permanent press and machine washable.

## CELANESE FORTREL AVRIL Cape Cod Curtains

30" Our Reg. 2.89	1.49	Our Reg. 2.79 <b>99<sup>c</sup></b> 24"
36" Our Reg. 2.99	1.99	
Valance, Reg. 2.29	1.49	

Crisp, white blend of 50% Celanese® Fortrel® polyester and 50% Avril® Rayon. Permanent press and machine washable.

## 25% OFF Our Reg. Low Prices All Drapery Hardware

By one of America's Leading Mfrs. All fashion decorator rods, all wood poles and accessories... all curtain rods, hooks, rings, holdbacks—and more.

Reg. 25c To 29.99 **18<sup>c</sup> TO 22<sup>50</sup>**

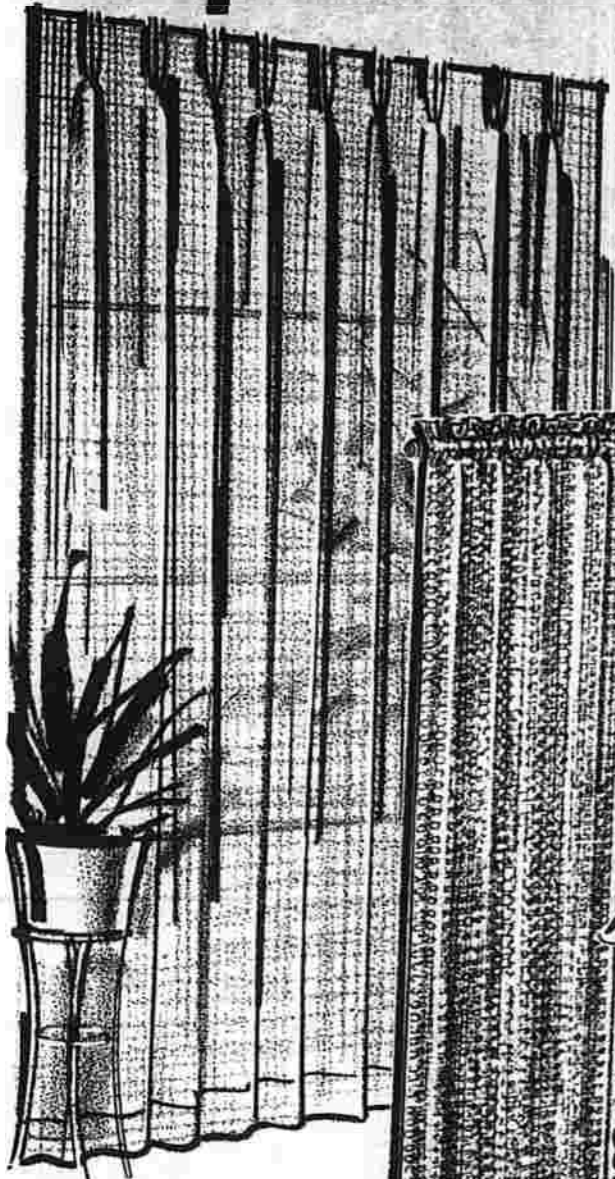
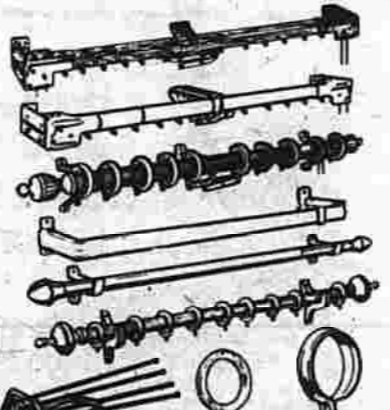

3 WAYS TO CHARGE

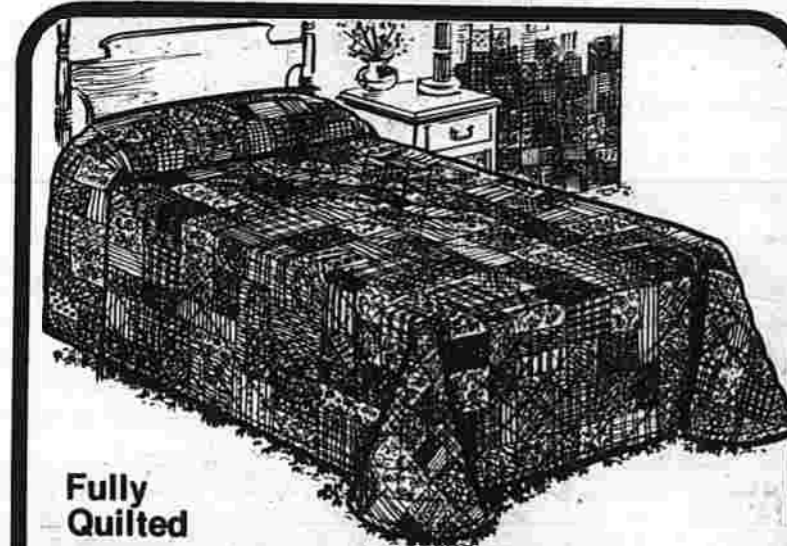

## Fully Quilted Fashion Print Bedspreads

Our Reg. 17.99 <b>14.40</b> TWIN	Our Reg. 22.99 <b>18.70</b> FULL
-------------------------------------	-------------------------------------

Queen, Reg. to 27.99 22.64  
84" Drape Reg. to 11.99 9.87

Choose from springy birch motif or patchwork patterns.

Not in Riverside.



Corduroy Bed Rest with Arms  
Reg. 9.99 **7.77**  
Stunning solid colors, kapok filled; enjoy leisurely reading or TV-ing.

**CANNON**  
Terry Towel Ensemble  
BATH SIZE **99<sup>c</sup>**  
Hand, Reg. 99c **79<sup>c</sup>**  
Wash, Reg. 49c **39c**  
Soft, thirsty terry in smart solid colors.

Kodel® 232 Filled Bed Pillow  
21x27" Reg. 4.99 **2.49**  
21x31" Reg. 6.49 **3.49**  
21x37" Reg. 8.49 **3.99**  
Odorless, non-allergenic poly fiberfill; machine washable.

Quilted Anchorband Mattress Pads  
TWIN Reg. 4.99 **3.84**  
Full, Reg. 6.59 **4.97**  
Queen, Reg. 8.69 **7.44**  
King, Reg. 10.99 **8.97**  
Resilient, lasting loft, with safe, non-allergenic properties.

# Super WHITE SALE!



## Famous PEQUOT No-Iron Gingham Check Sheets and Pillowcases

TWIN FLAT Reg. 3.99 Ea. **2 FOR \$5**  
TWIN FITTED, Reg. 3.99 ea. 2 for 5.50

FULL FLAT Reg. 4.99 Ea. **2 FOR \$7**  
FULL FITTED, Reg. 4.99 Ea. 2 for 7.50

Pillowcases, Reg. 3.49 Pkg. of 2 **2.99**  
Gingham check hem on solid color cases and flat sheets. Overall checks on fitted sheets.

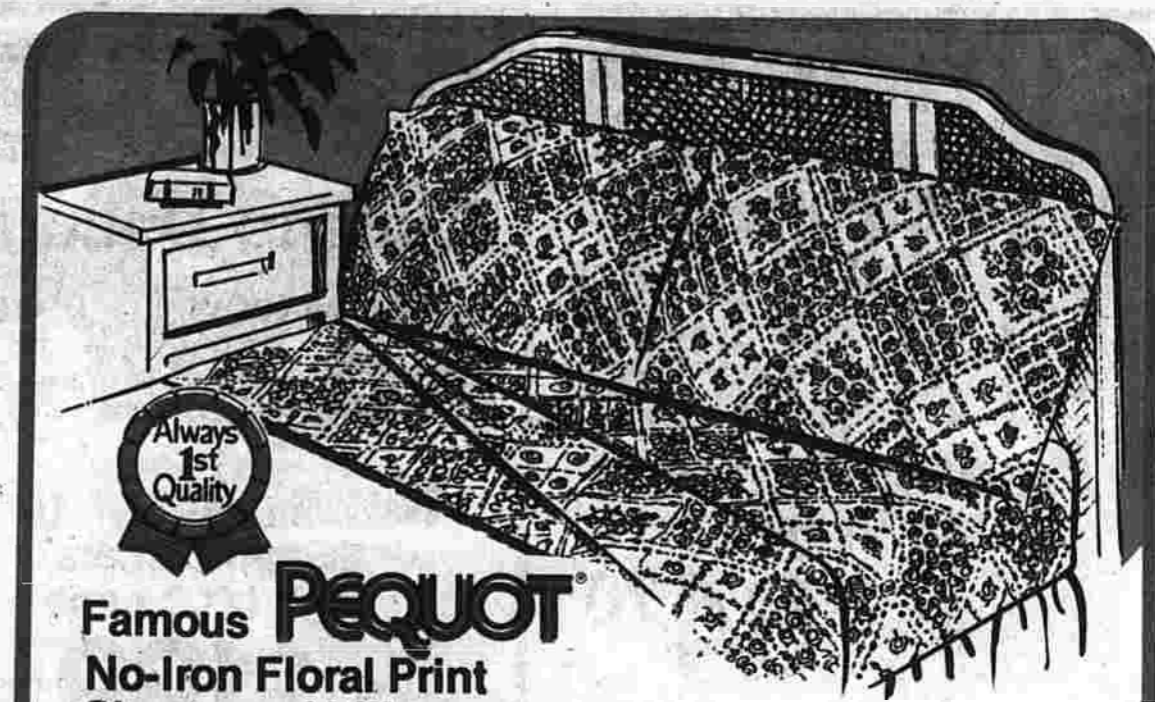

## Famous PEQUOT No-Iron Floral Print Sheets and Pillowcases

FULL FLAT Reg. 4.99 **2.99**  
TWIN FIT, Reg. 3.99 **2.29**  
Pillowcases 42"x36", Pkg. of 2 Reg. 3.49 **2.97**

Provincial Floral print in beautiful decorative colors. Easy care 50% cotton and 50% polyester.

**1.99**  
TWIN FLAT Reg. 3.99

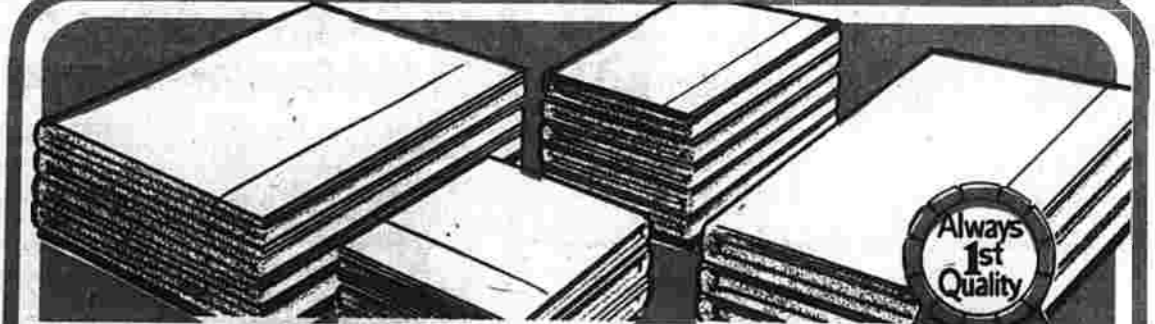

## Famous PEQUOT No-Iron Percale Sheets and Pillowcases

Full Flat, Reg. 4.99 **3.99**  
Queen Flat, Reg. 7.99 **6.99**  
King Flat, Reg. 9.49 **8.49**  
Full Fit, Reg. 4.99 **4.29**  
Queen Fit, Reg. 7.99 **6.99**  
King Fit, Reg. 9.49 **8.49**

Luxurious 180 thread count percale in snowy white. 50% polyester, 50% cotton.

**2.99**  
TWIN FLAT, Reg. 3.99  
TWIN FIT Reg. 3.99 **3.29**  
Pillowcases 42"x36", Reg. 2.99, Pkg. of 2 **2.79**  
Bolster Cases 42"x46", Reg. 3.99, Pkg. of 2 **3.79**

### Non-Slip Foam Backed Furniture Covers

#### Furniture Throws

60x70" Reg. 5.99	<b>3.84</b>
70x90" Reg. 8.99	
70x120" Reg. 10.49	
70x140" Reg. 12.99	

Progressive geometric print in seamless, washable 100% fine cotton.

#### Reclining Chair Covers

**7.70**  
Reg. 9.99

Foam backed stretch fabric assures perfect fit; no slipping; machine wash.

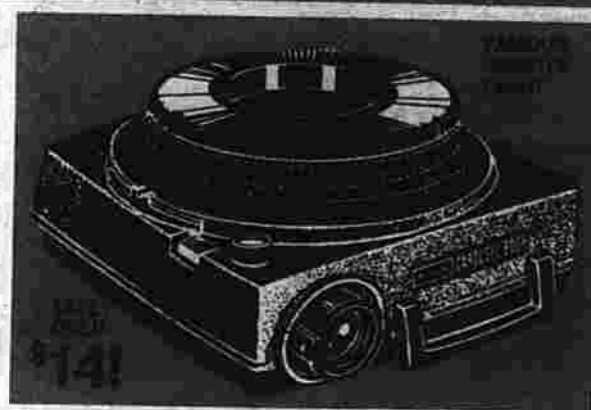

### Kodak Carousel Slide Projector

Push button slide advance, easy focusing and tray changing. Uses stack loader and 80-140 trays. Reg. 78.87

**64<sup>70</sup>**

KODAK 750 CAROUSEL PROJECTOR, Reg. 129.87 ..... **112<sup>33</sup>**

KODAK 140 CAROUSEL SLIDE TRAY, Reg. 4.99 ..... **4<sup>37</sup>**

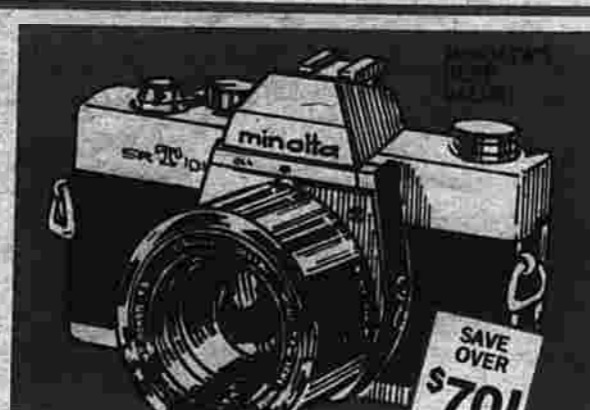

### Minolta SRT-101 35mm Camera with f/1.7 Lens

Our Reg. 269.87 **\$199** Fantastic Value!

Patented CLC metering, precision ground f/1.7 lens. Fully covered by 2 year warranty.



### Holson Stick-It-To-Me Photo Album

Six self-stick magnetic pages; many colors to choose from. Fits most size photos. Reg. 2.99

**1<sup>94</sup>**

3-PAGE REFILLS FOR STICK-IT-TO-ME, Reg. 99c ..... **77<sup>c</sup>**



### Famous Make Automatic Strobe

For 35mm Cameras

Our Reg. 29.99 **24<sup>70</sup>**

Shoe mount, PC cord; battery operated. Compact size. 24 per atom. No Banchicks.



### Kodachrome Slide Film Spring Sale!

KR110-20, KR126-20, KR135-20, KM135-20 ..... **1<sup>47</sup>**

KR135-36, KM135-36 ..... **2<sup>07</sup>**

## Vivitar

Presents The New Point 'n Shoot™ 110 Pocket Cameras!



### Vivitar 602 Pocket Camera Outfit

Our Reg. 59.99 **47<sup>66</sup>**

Simple drop in film loading, built-in electronic flash. Over 300 flashes to a set of batteries. Includes camera, batteries, film, wrist strap.



### Vivitar 402 Pocket Camera Outfit

Includes film, flashcube, wrist strap. Reg. 24.99 **19<sup>70</sup>**

### BORDERLESS SILK PRINTS!



### Kodacolor Film With Processing\*

Your Choice of • C110-20 • C126-20 • C135-20, 3R Prints

**4.59**

\*Processing by Leading Independent Lab

### STOP USING MAGICUBES!



### ITT Magicflash Electronic Flash

Our Reg. 16.99 **12<sup>44</sup>**

Synchronized to fit Kodak 20, 30, 40, 50, 60 plus other 110 pocket cameras. Simplify and improve your photography.



### RICOH 35mm Compact Automatic Camera

Our Reg. 84.99 **64<sup>70</sup>**

Light, compact and rapid handling! Built-in rangefinder, manual override, built-in hot shoe. Superb results, great savings!



### Costume Jewelry

Frosty white earrings, necklaces, ropes & bracelets to accent cool Summer costumes. **99<sup>c</sup>**

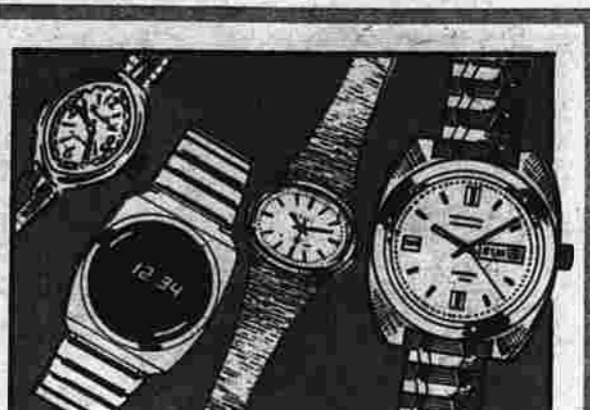

### Name Brand 17 Jewel Watches

• WALTHAM • HAMILTON • BENRUS • GRUEN & MORE

Reg. 39.97 **28<sup>40</sup>** Reg. 59.97 **37<sup>40</sup>**

Styles for men and women in sport or dress; smart fashions, automatic, calendars, electronics. Similar savings on all watches!



### Pendant Watches

Swiss movements, large, legible dials. Matching neck chains, attractive cases. Reg. 9.97 **6<sup>88</sup>**



### Mother's Day Rings

OVER 6 STYLES TO CHOOSE FROM!

Reg. \$20 **14<sup>70</sup>** Reg. \$45 **\$34** Reg. \$45

SOME FOR SPECIAL ORDERS—OTHERS FOR QUICK DELIVERY.



### Timex SSQ\* Digital Watches

See Our Entire New Spring Assortment!

\*SOLID STATE QUARTZ



### Personalized Pill Boxes

Woodtone, goldtone or silvertone finish metal pill boxes, plastic lined. **2<sup>88</sup>** Ea.



### Silhouette Charms

Boy and girl silhouettes—wear one for each child or grandchild. Reg. \$3 **1<sup>99</sup>** Ea.



### 14 Kt. Gold Hoop or Ball Earrings

SMALL, MEDIUM & LARGE HOOPS! 4, 5 & 6mm GOLD BALLS!

Reg. 7.47 to 9.97 **5<sup>88</sup>** Reg. 10.97 to 14.87 **8<sup>88</sup>**



### Hand Decorated Porcelain Lamps

Gift Dept. **\$21** Ea.



### Exquisite Hand Made European Crystal

Decorative scale, smoking stand, open weave bowl, candle sticks, candy box, etc. **12<sup>87</sup>** Ea.



### Fashion Designed Lockets

Gift Boxed! Our Reg. 10.97 **7<sup>88</sup>** Our Reg. 12.97 **8<sup>88</sup>**



### Decorative Cordless Clocks

Gift Dept. **\$19** Ea.



### Beautiful Floral Design Center Pieces

Our Reg. 4.79 **3<sup>70</sup>** Ea.



### Our Most Popular Photo Frames

Reg. to 2.89 **1<sup>37</sup>** Ea.

Double 5x7" & 8x10" goldtone, 5x7" & 8x10" walnut.



### Bone China Cups and Saucers

Our Reg. 8.99 **3<sup>17</sup>** Set

Elegant floral designs from England.



### English Hand Decorated 6-Cup Teapots

Our Reg. 8.99 **6<sup>70</sup>** Ea.

Assorted traditional shapes and designs.

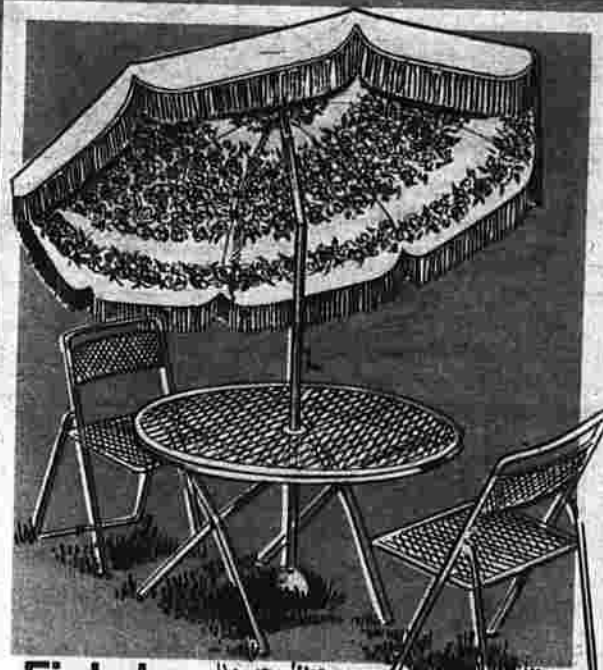

### Finkel Big 7 1/2 Ft. x 8 Rib Automatic Cranklift Umbrella

Our Reg. 44.99

# 31<sup>44</sup>

Push button to tilt-full or partial in either direction. Solid/floral combinations.

### 42" Steel Mesh Folding Table

Our Reg. 29.99

# 21<sup>40</sup>

Sturdy tapered legs, ball feet, super-hard baked on acrylic finish.

### Matching Mesh Folding Chair, Reg. 12.99



### 3-Pc. 70 Inch Clear Redwood Picnic Set

Our Reg. 54.99

# 43<sup>70</sup>

Kiln dried lumber with sanded tops. Factory water repellant stain, weather resistant hardware.

### Caldor's Own 20" Rotary Power Mower

# \$67

Reg. 79.99

Briggs & Stratton 3 H.P. 4 cycle engine, 7" wheels, T-handle, rear safety guard, side deflector chute.



### 7 Web Folding Chair

Our Reg. 8.99

# 6.70

Cool polished hardwood arms, big 7x5x4 webbed frame.



### 7-Web Folding Chaise

Our Reg. 14.99

# 11.40

Cool polished hardwood arms, 7x18 colorful webbed adjustable frame.



### 2-Tone Colors! Contour Lounge

Our Reg. 15.99

# 11.70

36-position rust resistant galvanized steel frame with foam head rest.

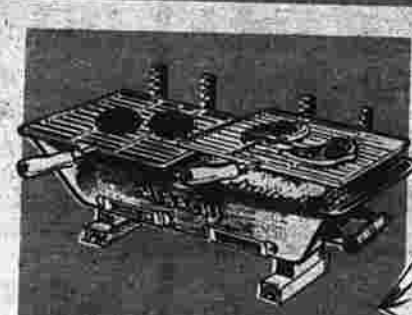

### 10"x17" Adjustable Double Hibachi

Our Reg. 8.99

# 5.66

Cast iron bowl, twin chrome grids, vent controls; wooden handles and base.

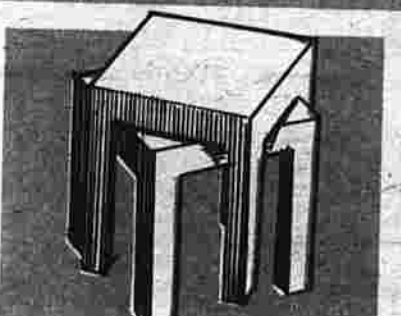

### 16"x16" Indoor / Outdoor Colorful Stack Tables

Our Reg. 5.99

# 3.88

Easily assembled heavy gauge plastic in House & Garden colors.



### 24 1/2" Deluxe Bar-B-Q Grill

Our Reg. 15.99

# 11.70

Grid adjusts to 5 positions; tapered steel legs with 5" "mag" wheels.

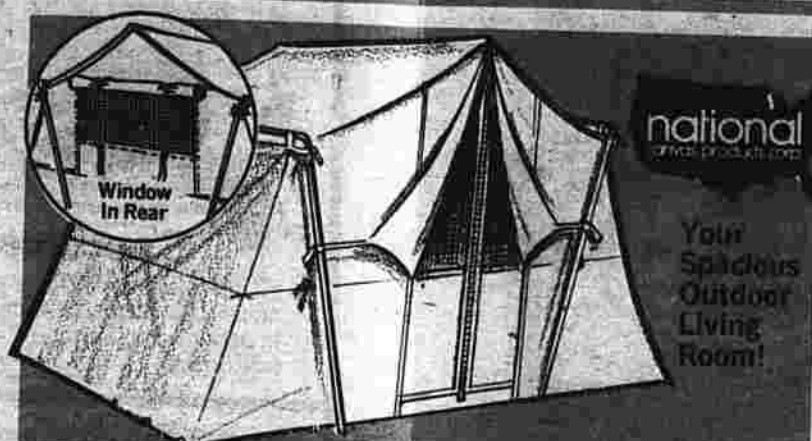

### Flame Retardant 9'x12' Cabin Tent

with Heavy Duty Drill Fabric Outside frame with adjustable center ridge. Sunflower roof, mint green walls, large screened window.

# \$69

Our Lowest Price Ever!

8'x10' Flame Retardant Cabin Tent, Our Reg. 89.99



### Large 10'x16' Tent

Our Reg. 149.99

# 119<sup>70</sup>

Outside frame, adj. center ridge. H.D. Drill Fabric. Screened door and windows. Flame retardant.



### 30' Oval Pool Package with 6" Deck

'Barnwood wall', vinyl coated-bottom rail. Fiberglass reinforced filter, aluminum safety ladder, thru-wall skimmer. IF PURCHASED SEPARATELY \$1,209

# \$897

### 24" Round Pool Package

Barnwood style, 1/2 H.P. fiberglass tank sand filter; many features. IF PURCHASED SEPARATELY \$849

# \$674

### 18' Round Pool Package

Same features as pool above. If purchased SEPARATELY \$689

# \$543

SAVE \$41

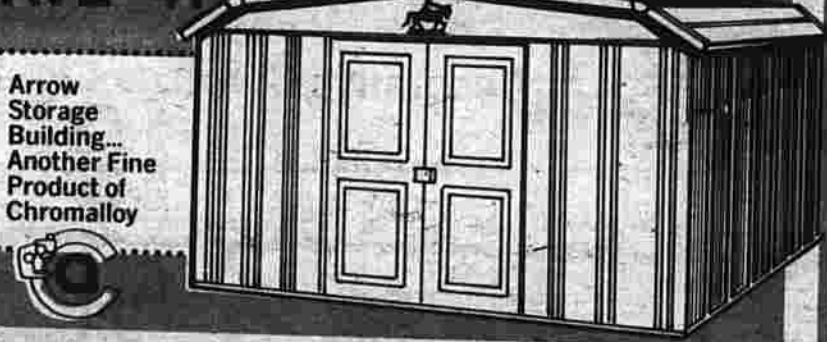

### Giant 10' Wide Storage Building

High arch gambrel roof gives extra headroom. Durable perma-plate all season ribbed steel panels, lockable door handles. Approx. size 10'x7'x6'4"

Our Reg. 169.99

# \$129

10'x10'x6'4" Storage Building, Our Reg. 219.99 \$169

All Sizes Approximate



### Black & Decker® PRICE BREAK!

#### 13" Shrub & Hedge Trimmer

Double safety insulated cord holder, safety switch; sturdy front grip. #8104

Reg. 15.99

# 13<sup>87</sup>

#### 16" Deluxe Double Edge Hedge & Shrub Trimmer

Full wrap around handle; die-cast alum. #8121

Reg. 22.88

# 16<sup>84</sup>

#### Convertible Long Handle Cordless Grass Shear

Battery charger included. #8290

Reg. 26.99

# 19<sup>74</sup>



### tension Steel Tennis Racket

Our Reg. 18.99

# 13<sup>88</sup>

For the serious player! Strung with top grade Black Cross nylon; deluxe leather grip. Frame guar. unconditionally 1 yr.

### Practice Tennis Balls

117

Reg. 1.67 Pressure packed 3 to can. Super value!



### Spalding Men's 11-Pc. Golf Set

Our Reg. 79.99

# \$64

Consists of 8 irons, 3 woods. Tempered steel shafts are designed for power and consistency. Save over \$15!



### Pro Shop Golf Balls

# 11<sup>64</sup>

Choose from Titleist, Maxfli or Royal Plus 6-3 great names! Not sure?—try all three!



### 2-Man Inflatable Boat

Our Reg. 18.99

# 14<sup>70</sup>

Self-locking safety valves; oarlocks & holders, bow handle and inflatable floor.

### 1-Man Inflatable Boat

With carry bag, repair kit; 1 yr. warranty. Reg. 13.99

# 9<sup>87</sup>

### Buoyant Life Vests

# 3<sup>77</sup>

A boatsman's necessity! Come in small, medium or large sizes.

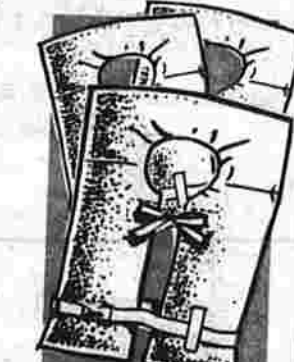

U.S. Coast Guard Approved

### Buoyant Boat Cushions

# 4<sup>44</sup>

Kapok filled vinyl leatherette. Welded seams; 4 bright colors.



### Lightweight, Comfortable "Electra" Water Safety Foam Vests

# 10<sup>70</sup>

Nylon covered cellular foam, U.L. and U.S.C.G. approved. Assorted colors.



### 3 H.P. Fishing Motor by ESKA

# \$129

Slow troll to 9 m.p.h. Economical single cylinder engine; weighs 32 lbs.

### 5 H.P. Outboard Motor by ESKA

# \$169

Air cooled engine, twist-grip controls. Slow troll to 11 m.p.h.; 39 lbs.



### Play Center by Roth American

# 47<sup>40</sup>

Reg. 59.88

7 feet long, over 7 ft. high. Includes features shown, but most important feature is Fun!

### Big 6-Leg Play Gym

# 57<sup>66</sup>

Reg. 74.88

2 swings, chin bar, 2 seat glider, trapeze bar; 4 passenger lawn swing, big slide.



Hamilton Beach Crock Watcher

Our Reg. 21.97 **15<sup>87</sup>**

Cook inexpensive cuts to prime tenderness! 4-qt. size crock cooks automatically high-low; save on fuel, eat well. # 449R/448R



Hamilton Beach 14 Speed Blender Plus

Our Reg. 21.97 **17<sup>40</sup>**

Push button controlled 14 speeds; 40 and 14 oz. containers for blending or storage. A speed for every need. # 688

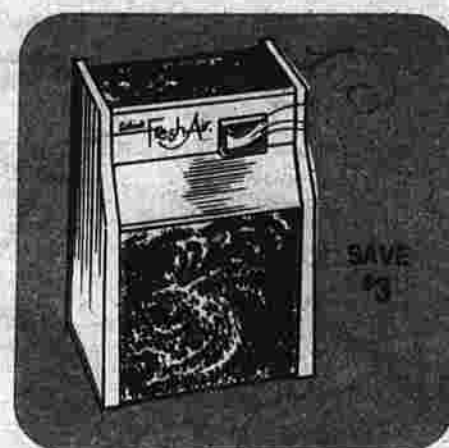

The Schick Freshair Machine

Our Reg. 15.99 **12<sup>77</sup>**

Eliminates unpleasant, stale household odors, automatically dispenses fragrance. # 400  
Schick Freshair Refill Available

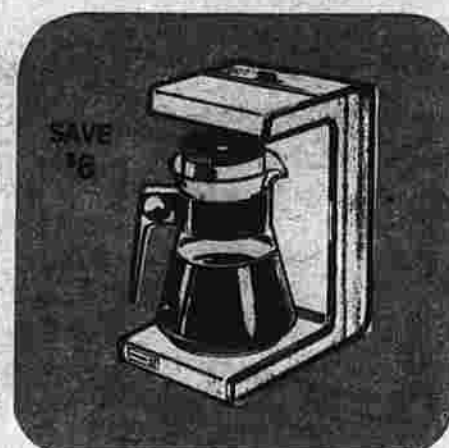

Norelco 12-Cup Drip Coffeemaker

Our Reg. 34.99 **28<sup>94</sup>**

Superfast brewing, never a bitter taste. Big 12-cup size. # HD5135  
8-Cup # HD5130, Reg. 27.99 21.73



Clairol "Set-To-Go" Hair Setter

Our Reg. 13.99 **9<sup>99</sup>**

Great for travel or office—just 5 minutes for a refresher! Has 5 tangle-free rollers. # K55

# More Rebates at Caldor!



The Super Max by Gillette

Our Reg. Price ..... 19.99  
You Pay Caldor ..... 15.99  
Less Gillette Rebate \*\* ..... 3.00

**YOUR FINAL COST 12<sup>99</sup>\***

650 watts of drying power, 2 drying speeds, 5 drying and styling attachments. HD-7



Gillette Super Curl 3-in-1 Curling Iron

Our Reg. Low Price ..... 23.99  
You Pay Caldor ..... 17.99  
Less Gillette Rebate ..... 4.00

**YOUR FINAL COST 13<sup>99</sup>\***

Super styler with steam for curls or straightening. Small and large roller. # SW1



Gillette Super Curl Dial-A-Curl

Our Reg. Low Price ..... 19.99  
You Pay Caldor ..... 15.99  
Less Gillette Rebate ..... 4.00

**YOUR FINAL COST 11<sup>99</sup>\***

**REBATE CERTIFICATE**  
Enclosed are my dated store receipts from my purchase of Pro-Max TM Professional Styler/Dryer and/or Super Curl TM or Super Curl 3 in 1 TM Steam Styler, and the complete front cover from each instruction booklet.  
The refunds I am requesting are:  
(Check one only)  
 \$10.00 on purchase of both Pro-Max and either Super Curl Steam Styler or Super Curl 3 in 1 TM Steam Styler.  
 \$4.00 on purchase of either Super Curl Steam Styler.  
 \$3.00 on purchase of Pro-Max.  
Name \_\_\_\_\_  
Address \_\_\_\_\_  
City \_\_\_\_\_ State \_\_\_\_\_ Zip \_\_\_\_\_  
Place in a stamped envelope. Postmarked no later than July 31, 1975, and mail to: CASH REBATE, P.O. Box 4156, Kankakee, Illinois 60901  
Please allow at least six weeks for delivery of your rebate. Please note these additional terms:  
1. Offer good only in U.S.A.  
2. This certificate may not be reproduced and must accompany your request.  
3. Your offer rights may not be assigned or transferred.  
4. Offer void where prohibited, taxed or restricted by law.  
5. Offer good on purchases from April 1, 1975 through June 30, 1975.  
6. Cash value 1/20th of 1c.  
(C) The Gillette Company



Remington Men's Radial Shaver

You Pay Caldor ..... 25.88  
Less Rebate from Remington 5.00\*

**YOUR FINAL COST 20<sup>88</sup>\***

New contoured head adjustment for closer shave; Hideaway Trimmer, # RCS



Lady Remington Shaver

You Pay Caldor ..... 13.88  
Less Rebate from Remington 2.00\*

**YOUR FINAL COST 11<sup>88</sup>\***

One head for underarms, one for legs. Supersharper replacement blade. # MS140

Remington Radial World Wide Shaver #RR-1

You Pay Caldor ..... 32.97  
Less Rebate from Remington 5.00\*

**YOUR FINAL COST 27<sup>97</sup>\***

Adjustable groomer for trimming sideburns, mustache or beard; 5 position dial. # 75-19



Sunbeam Trade-In Shaver Sale

You Pay Caldor ..... 27.99  
Less Trade-In from Sunbeam 8.00\*

**YOUR FINAL COST 19<sup>99</sup>\***

Adjustable groomer for trimming sideburns, mustache or beard; 5 position dial. # 75-19



Sunbeam Ladies' Twin-Head Shaver

**13<sup>99</sup>\***

Two shaving heads, push button release. Includes built-in shaving light. # 76-27



SPECIAL! Sunbeam Mist Stick Curler/Styler

**1.99\*** WITH PURCHASE OF ABOVE SHAVERS AT 13.99



Hamilton Beach Electric Knife

Our Reg. 13.49 **9<sup>87</sup>**

Hole-in-handle gives perfect balance, easy carving. Stainless steel blades retain edge, clean easily; safety switch. # 296



The Mighty Max by Gillette

Our Reg. Price ..... 23.99  
You Pay Caldor ..... 18.99  
Less Gillette Rebate \*\* ..... 3.00

**YOUR FINAL COST 15<sup>99</sup>\***

Mist sprayer, 2 drying settings, 850 watts of super power.

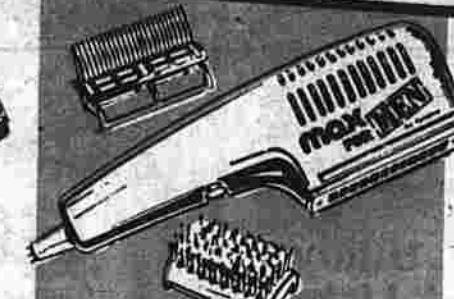

Gillette Max for Men Styler Dryer

Our Reg. Price ..... 19.99  
You Pay Caldor ..... 15.99  
Less Gillette Rebate \*\* ..... 3.00

**YOUR FINAL COST 12<sup>99</sup>\***

A man's own styler! 650 watts of drying power, 2 versatile speeds.



The Max Hatter by Gillette

Our Reg. Price ..... 19.97  
You Pay Caldor ..... 15.97  
Less Gillette Rebate \*\* ..... 3.00

**YOUR FINAL COST 12<sup>97</sup>\***

Inflates for fast salon drying; 15' cord for freedom.

\*\*IN ORDER TO QUALIFY FOR REBATES ON SUPER MAX, MIGHTY MAX, MAX FOR MEN OR MAX HATTER CONSUMER MUST PURCHASE ONE GILLETTE RIGHT GUARD ANTI-PERSPIRANT

## REGINA FLOORCARE APPLIANCES

**3-Speed Elektrbroom Vacuum**  
Our Reg. 34.88

**27<sup>40</sup>**

Extra power from 3-speed motor; shag rake attachment plus rug pile-dial for rugs to bare floors. # RB2536

Shag Rake Attachment Included

**Regina Shampooer Floor Polisher**  
Our Reg. 39.88

**27<sup>66</sup>**

Heavy duty 400 watt motor waxes, scrubs, buffs, shampoos, polishes. Big 90 oz. liquid dispenser. # 1033

**Regina Duo-Vac Vacuum Cleaner**  
Our Reg. 109.88

**89<sup>40</sup>**

The power of a canister, the brush and beat of an upright cleaner—really 2 vacuum cleaners in one! # V540/ V525

**Hoover Upright Vacuum Cleaner with Tools**

Reg. Price of Upright ..... 69.88  
Reg. Price of Tools ..... 12.88  
Total Price of Both ..... 82.76

**59<sup>88</sup>**

Rug nozzle adjusts to 4 positions; cleans bare floors to deep shag rugs. Rugged 2-speed motor, through going cleaner.

SAVE OVER \$22



Hamilton Beach Deluxe Stand Mixer

Our Reg. 46.97 **36<sup>44</sup>**

10 position speed control, stainless steel bowls, chromed beaters clean easily. Beater ejector. # 40C

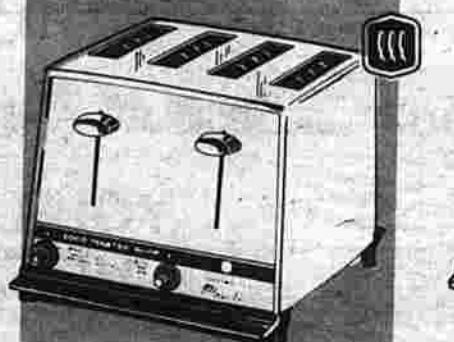

Toastermaster Deluxe 4-Slice Toaster

Our Reg. Price ..... 34.99  
You Pay Caldor ..... 26.99  
Less Toastermaster Rebate 2.00

**YOUR FINAL COST 24<sup>99</sup>\***

Holds 1 to 4 slices for toast, or toaster foods; Superflex™ timer. # D114

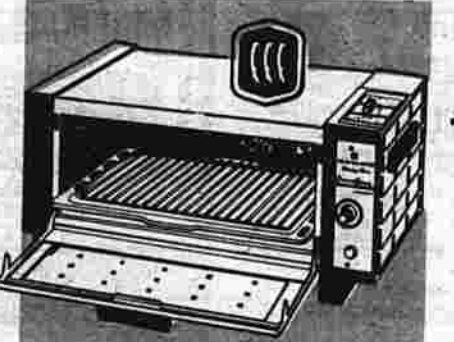

Toastermaster Push-Button Clean Oven Broiler

Our Reg. Price ..... 43.99  
You Pay Caldor ..... 34.99  
Less Toastermaster Rebate ..... 3.00

**YOUR FINAL COST 31<sup>99</sup>\***

Cleans continuously as it bakes or roasts. Pushbutton for bake, broil, off. # 5242

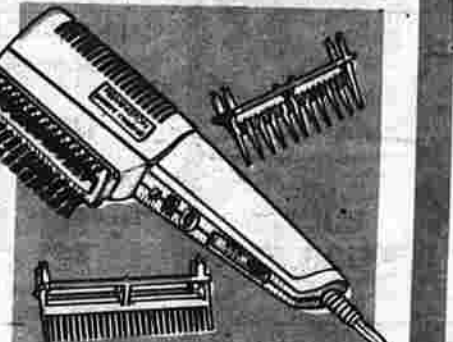

Remington 900 Watt Power Control Dryer

Our Reg. Price ..... 26.99  
You Pay Caldor ..... 21.99  
Less Remington Rebate ..... 3.00

**YOUR FINAL COST 18<sup>99</sup>\***

900 watts of super drying power. Regulated airflow for drying/styling. PD-900

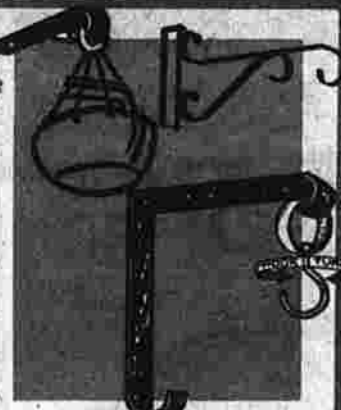

### Tremendous Selection of Plant Hangers

- HERE ARE SOME EXAMPLES
- ROTATING HOOK **49<sup>c</sup>**  
Our Reg. 59c
  - WINDOW BRACKET **69<sup>c</sup>**  
Reg. 79c
  - PLANT HANGER BRACKET **99<sup>c</sup>**  
Reg. 1.19
  - SWIVEL HANGER **2.79**  
Reg. 3.29



### 14"x54" Door Mirror

Our **4<sup>99</sup>**  
Reg. 7.99

Brass finish metal frame is easy to install on door or wall. Packed in easy-carry carton.

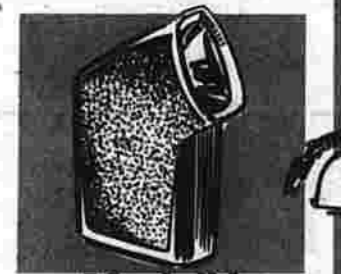

### Mark IV Dispoz-A-Lamp

Our **99<sup>c</sup>**  
Reg. 1.49

Corrosion and rust resistant. Ideal for car, kids, pockets.

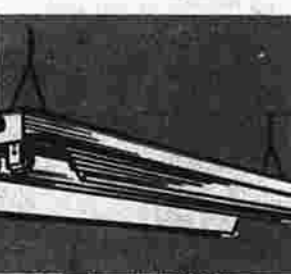

### 4 Ft. Utility Work Light

Our **12<sup>87</sup>**  
Reg. 15.99

For utility room, cellar, workshop. Includes bulbs.



### Du Pont Lucite® Wall Paint

Our **7.44** Gal.  
Reg. 8.99

Goes on easily, dries fast. Good color choice; soap/water clean up.

Caldor Wall Paint **4.44** Gal.  
Washable, odorless. Reg. 5.99



### Du Pont Lucite® House Paint

Our **8.44** Gal.  
Reg. 9.99

Built-in primer; dries in an hour. Tough, long lasting. Soap/water clean up.

Caldor House Paint **5.17** Gal.  
Thorough covering, dries fast. Reg. 6.99



### Aluminum Extension Ladders

16 Ft. **19<sup>94</sup>** Reg. 24.99  
20 Ft. **25<sup>70</sup>** Reg. 31.99  
24 Ft. **32<sup>99</sup>** Reg. 38.99  
28 Ft. **38<sup>70</sup>** Reg. 44.99

6 Ft. Sturdy Step Ladders

ALUMINUM **15<sup>44</sup>** Reg. 18.99  
WOOD **11<sup>66</sup>** Reg. 14.99

## Savings For Your Car!



**Quaker State 10W30 Motor Oil**  
Our Reg. 74c

Limit 6 quarts per Customer

**57<sup>c</sup>** Qt.

Oil Pouring Spout... **49<sup>c</sup>**



**The Great "Rally" Rebate!**

**Rally Cream Wax**  
10 oz., Reg. 1.39

**88<sup>c</sup>**

14 OZ., Reg. 1.89 1.47  
18 OZ., Reg. 2.29 1.87

Famous pre-softened wax for that new car shine! Handy applicator.

\*See Clerk for Details

### Extra Savings with LEE Rebates, Too!



### LEE Oil Filters

LF-1 **1.57**  
Our Reg. 2.19

LF-7, 24, 25 **1.77**  
Our Reg. 2.69

LF-16 (Small Cars) **1.67**  
Our Reg. 2.49



### LEE Maxifilters

LF-1 Maxi **1.97**  
Our Reg. 2.99

LF-7, 24, 25 Maxi **2.27**  
Our Reg. 3.19

LF-16 Maxi (Small Cars) **1.97**  
Our Reg. 2.99

\*See Clerk for Details

**60<sup>c</sup>** CASH REBATE

From LEE with the combined purchase of a LEE Oil Filter and any LEE Air Filter.

**80<sup>c</sup>** CASH REBATE

From LEE with the combined purchase of a LEE Maxi Oil Filter and any LEE Air Filter.

### Rubbermaid Full or Twin Front Rubber Mats

**YOUR CHOICE 4.44** Reg. 5.99 and 5.49

Trim-line for custom fit. For American medium and large cars; asstd. colors.

Mini Mats, For compact cars. Our Reg. 4.99 **3.77** Pr.

### Famous TUNE UP Equipment

**YOUR CHOICE 26<sup>40</sup>**

**Test & Tune Kit #9638**  
Contains: Timing light w/ remote starter, compression tester, vacuum/fuel pump and dwell-tach testers. Reg. 33.99

**Maxi Tune Ignition Analyzer #560**  
Measures dwell, RPM on 4-6 cyl. engines, helps adjust for smooth performance. Reg. 34.99

**3-Pc. Test & Tune Kit #827**  
3 piece test and tune kit has instructions for the layman, rugged carry case. Reg. 29.99

## Favorite Toys & Games



### Hot Wheels by Mattel

Our **59<sup>c</sup>** EA.  
Reg. 89c

Die-cast metal; tough and sturdy. Great looking with flying colors.

**9" Play Ball**

Our **67<sup>c</sup>**  
Reg. 97c

Big ball for outdoor Spring games.

**Pizza Pie Game by Bradley**

Our **347**  
Reg. 4.99

The Yummy Rummy Pizza Game Plays like the game of Rummy.

**Playskool Woodboard Puzzles**

Our **1.99**  
Reg. 2.89

Choose from many favorites. Great fun for the youngsters!

**Za-Zoom Power Mower by Marx**

Our **1.88**  
Reg. 2.49

Real mower sound. Rugged plastic construction.

### GREAT FUN FOR THE LITTLE TOTS

**Swyngomatic Automatic Swing**

Our **8.94**  
Reg. 11.99

Wind up and baby enjoys automatic swinging. Sturdy non-skid legs. Great gift for the new baby!

**Swyngomatic Lightweight Sitter Stroller**

**9.84**

Folds easily, only weighs 8 lbs. Attractive pattern, sturdy seat. Makes a great extra stroller for travel.

24 per store No rainchecks

**Portable Crib with Mattress**

**21.74** Reg. 28.99

Natural finish hardwood. Large lucite casters. 2" thick attractive mattress.

Juvenile Dept. Not in Riverside

**2-Seat Sand Box**

Our **12.70**  
Reg. 15.99

Silk-screened blue denim seats. Red/white gingham vinyl canopy. All prints non-toxic.

**4-Seater** Reg. 21.99 **17.40**

**Swag Lamp or Ceiling Fixture**

**SAVE \$10**

**Tiffany Style Lamp**

For Living room, Foyer, or Dining room. Your choice of amber, ruby or blue.

Our **19.70**  
Reg. 29.94

**Lights for Hall-Bedroom or Outdoors**

**YOUR CHOICE 1.87** Ea.  
Reg. 2.69

Hall: polished brass, hobnail glass. Bedroom: starburst design on white glass. Wall: black finish cylindrical glass.

### America's Favorite Bike for Every Member of the Family

**Huffy "Grande" 10-Speed Racer**

SAVE **\$30**

Our **\$64**  
Reg. \$94

A deluxe bike for the serious cyclist; Shimano Derailleur, Centerpull brakes with safety levers; 27x1 1/4" Gumwall tires.

**Huffy 26" 3-Speed Bike**

SAVE **\$16!**

Our **\$57** Reg. 73.99

3-Speed Gear; front and rear; Handbrakes. Boys' and girls' models.

**Huffy Thunder Road 20" Convertible**

SAVE **\$12!**

Our **\$57.66**  
Reg. 69.99

A great looking 20" bike with "Dirt-Bike" motorcycle styling. Motorcycle style handlebars and grips. Many added features.

Our **\$37.44**  
Reg. 53.99

Converts from boys' to girls' model. Coaster brake 20x1.75, inflatable tires, training wheels included.

### QUALITY BICYCLE ACCESSORIES FROM HUFFY

- Bicycle Speedometer** Reg. 8.99 **5.94**  
Sizes for 20", 24", 26", 27" bikes.
- Bicycle Luggage Rack** Reg. 5.99 **3.70**  
Vinyl coated alloy; 2/8" elastic luggage straps.
- Combination Chain Lock** Reg. 2.29 **1.47**  
Vinyl plastic covered steel chain.
- Hedstrom Trail Cycle** Our **13.40**  
Reg. 17.99  
Low-slung design for stability. Knobby front tires for traction. Tubular steel frame for strength.



**abc Records**

- **Joe Walsh** "So What" Series F6.98
  - **Steely Dan** "Katy Lied" Series F6.98
  - **Jimmy Buffett** "A1A" Series F6.98
  - **Rufus** featuring Chaka Kahn "Rufusized" Series F6.98
  - **Ace** "An Ace Album" Series F6.98
  - **Young Frankenstein** "Movie Soundtrack" Series F6.98
- ALL OTHER LPS BY THESE ARTISTS ARE ALSO ON SALE!



- **Alice Cooper** "Welcome To My Nightmare" Series F6.98
  - **Elvin Bishop** "Juke Joint Jump" Series F6.98
  - **Carly Simon** "Playing Possum" Series F6.98
  - **Judy Collins** "Judith" Series F6.98
  - **Bad Company** "Straight Shooter" Series F6.98
  - **Eric Clapton** "There's One In Every Crowd" Series F6.98
- ALL OTHER LPS BY THESE ARTISTS ARE ALSO ON SALE!

Series E5.98    Series F6.98    Series 7.98    Series 11.98    Series 12.98  
**3<sup>38</sup>    4<sup>17</sup>    4<sup>84</sup>    6<sup>88</sup>    7<sup>88</sup>**

**COLUMBLA**

- **Chicago VIII** Series F6.98
  - **Bob Dylan** "Blood on The Tracks" Series F6.98
  - **Blue Oyster Cult** "On Your Feet Or On Your Knees" Series 7.98
  - **Earth, Wind & Fire** "That's The Way Of The World" Series F6.98
  - **Mac Davis** "All The Love In The World" Series F6.98
  - **Janis Ian** "Between The Lines" Series F6.98
  - **Labelle** "Nightbirds" Series E5.98
  - **Michael Murphey** "Blue Sky Night Thunder" Series E5.98
- ALL OTHER LPS BY THESE ARTISTS ARE ALSO ON SALE!



- **John Denver** "An Evening With John Denver" 2 Record Set—Series 12.98
  - **David Bowie** "Young Americans" Series F6.98
  - **Elvis Presley** "Promised Land" Series F6.98
- ALL OTHER LPS BY THESE ARTISTS ARE ALSO ON SALE!

**KRAFTWERK "Autobahn"**

Series F6.98 **4<sup>17</sup>**



**Lloyds AM/FM Digital Clock Radio**

Our Reg. 29.88 **21<sup>74</sup>**  
 Unique rotary tuning dial, big, easy to read digits. Walnut grained cabinet. Wake to music.



UNIQUE DESIGN!  
**Panasonic Portable Eight Track Player**  
 OUR LOW PRICE **39<sup>95</sup>**  
 AC/DC operation; 6" speaker, carry handle you push to change program. Batteries included.



**AIKO Compact Cassette Tape Recorder**

Our Reg. 34.88 **24<sup>70</sup>**  
 Deluxe keyboard function controls, automatic level control, rempte. Dynamic microphone for superior recording. Operates on batteries (included)—or house current. Includes 30 minute tape.



SAVE OVER \$10!  
 Our Reg. 39.88 **31<sup>64</sup>**  
 Features jam resistant changer, self-storing 45 RPM adapter. High impact case is scuff resistant.



MUSIC ON THE GO!  
**General Electric AM/FM Portable Radio**  
 Our Reg. 23.88 **19<sup>73</sup>**  
 AFC on FM for less station drift. Operates on batteries (optional) or house current.



FOR HAMSTERS or GERBILS!  
 SAVE OVER \$5.00  
**Habitrail Set**  
 A NATURAL HABITAT THAT GROWS & GROWS!  
 Our Reg. 17.59 **11<sup>90</sup>**  
 Non-drip water bottle, snap-trap clean tray. Many hints in owner's guide.



Oster Electric Pet Groomer Clipper Set  
 Reg. 16.59 **10<sup>70</sup>**  
 10 Gallon Tank And Mark III Reflector  
 Reg. 15.84 **9<sup>77</sup>**  
 Bon Bone 100% Natural Beehive with Free Treat! **1<sup>47</sup>**



**Nylon Continental Dome Luggage**  
 SAFARI TOTE  
 Our Reg. 9.99 **7<sup>33</sup>**  
 22" Reg. 14.99 ..... **11<sup>70</sup>**  
 24" Reg. 19.99 ..... **15<sup>77</sup>**  
 26" Reg. 22.99 ..... **18<sup>37</sup>**  
 28" Reg. 25.99 ..... **19<sup>84</sup>**

New luggage for Mother! Extra wide sizes, heavy duty zippers, padlock closures. Chocolate brown with tan trim or blue with red trim. Washable vinyl interiors. I.D. tag with chain. Strap & buckle.

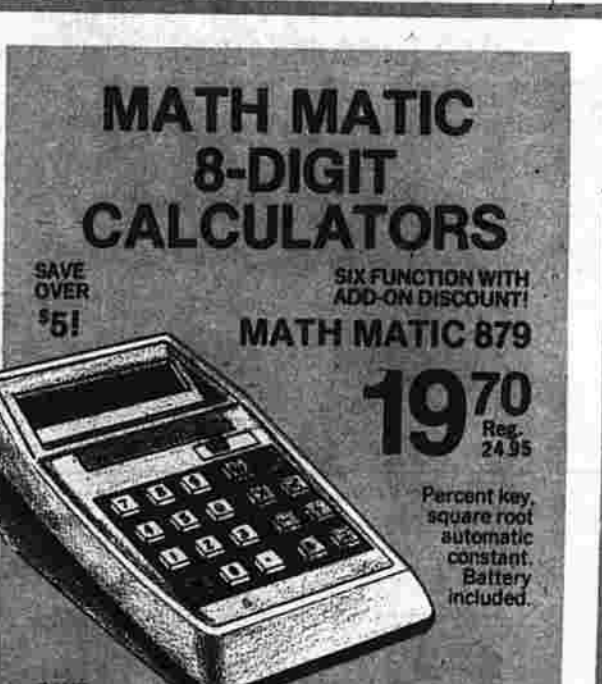

**MATH MATIC 8-DIGIT CALCULATORS**  
 SAVE OVER \$5!  
 SIX FUNCTION WITH ADD-ON DISCOUNT!  
**MATH MATIC 879**  
 Reg. 24.95 **19<sup>70</sup>**  
 Percent key, square root automatic constant. Battery included.  
 MINI CALCULATOR WITH TRUE MEMORY!  
**MATH MATIC 888**  
 Reg. 49.95 **\$31**  
 Full 4 function performance; automatic constant, percentage key. Rechargeable batteries.  
**BOTH CALCULATORS HAVE AC ADAPTERS AND 1-YEAR WARRANTIES!**



# Save on Famous Brand Appliances



Two Flash Freeze Shelves  
4.8 Cubic Ft. Capacity



**SANYO**  
Upright Freezer

White Only  
Reg. 169.81

**\$157**

Counter top height for convenience. Large capacity storage door. 2 flash-freeze shelves.

Available in Walnut, Reg. 174.88 **\$164**



**General Electric**  
Carry Cool 4,999 BTU  
Portable Air Conditioners

STARTING AS LOW AS

**\$119**

4,000 BTU's 7 1/2 amperes, weighs only 43 lbs. Durable, long lasting Lexan case.



**Emerson**  
Quiet-Cool 8,000 BTU  
Air Conditioner

Our Reg. 199.95

**\$168**

Two speed fan, 115 volts, 11.5 amperes. Adjustable air directors, and thermostat. Energy efficiency ratio 6.4.



FOR BAR TRAILER OFFICE

SAVE OVER \$15!

**SANYO**  
Cube Style Refrigerator  
with Freezer Section

Full range thermostat control, 2 adjustable shelves, meat keeper, dairy bar door.

Our Reg. 114.88

**\$99**

Available in Walnut, Reg. 119.88 **\$104**



**MAGIC CHEF, Easy-To-Clean**  
30" Gas or Electric Range

Our Reg. 199.70

**\$177\***

Big 25" oven with no-spill edge; lift up cooking top for easy cleaning. White, copper, avocado or gold.

30" GAS OR ELECTRIC CONTINUOUS CLEANING RANGES

With oven window ..... Our Reg. 219.70 **\$197**

Oven window, light, digital clock, timer Reg. 249.70 **\$217**



**MAGIC CHEF, Convertible**  
Portable Dishwasher

Our Reg. \$238

**\$208\***

Six pushbutton cycles, double spray arms, 12-blade macerator. Porcelainized tub, built-in sanitizer. Rollout racks, flatware basket, 1 1/4" maple cutting board top.



**Whirlpool**  
17 Cubic Foot NO-FROST  
Refrigerator-Freezer

Our Reg. 399.95

White Only

**\$368\***

Reversible door, separate refrigerator/freezer temp controls. Meat keeper, big steel crispers. Super storage!

**Westinghouse Matching Washer and Dryer**

BUY THE PAIR FOR

**\$358\***

SAVE AN EXTRA \$20

18 Lb., 2-Speed Automatic Washer

Our Reg. 239.95

**\$209\*** If bought separately

Bleach dispenser, 5 position water saver, Heavy duty agitator, lint filter, porcelain tub.

Heavy Duty Electric Dryer

Our Reg. 189.95

**\$169\*** If bought separately

Four temperature selections, permanent press setting, cool down period. Extra large basket.

Available for gas ..... **\$189**

\*Prices include delivery and 1-Year In-Home Service



**SHARP**

100% SOLID STATE  
COLOR PORTABLE TV

19" diagonal

Our Reg. 349.70

**\$299**

SAVE OVER \$50!

Lambert in-line color picture tube, automatic fine tuning, instant picture and sound, Walnut cabinet.



SAVE OVER \$11

**RCA** 12" diagonal  
100% Solid State B/W TV

Click stop UHF-VHF tuner. Bright, clear, crisp picture. Ear phone and jack. Walnut cabinet.

Our Reg. 99.70

**\$88**



**GRUNDIG**  
45" Wide  
CONSOLE  
STEREO

Our Reg. \$159

**\$119\***

SAVE OVER \$40

AM/FM/FM multiplex stereo radio. Built-in 8-track tape player. Full feature turntable. \*Free delivery.

Grundig 60" Console, Reg. 229.70 **\$169**



SAVE OVER \$22

**RCA** 19" diagonal  
Portable B/W TV

One set VHF tuning, 70 position UHF tuner, 3/4 inch tone-balanced speaker.

Our Reg. 139.70

**\$117**

**Electro-Phonic**  
AMERICA'S LARGEST STEREO MANUFACTURER

STEREO SYSTEMS



READY FOR 4 CHANNEL STEREO

AM/FM, FM Stereo Radio  
• 8 Track Tape Player  
• Stereo Phono System

**\$127** COMPLETE

Our Reg. 139.95

Full size BSR record changer, 6 speaker air suspension audio system, slide controls for volume, treble, bass and balance. Radar tuning dial. Headphone jack.



AM/FM, FM Stereo Radio  
Stereo Phono System

Our Reg. 99.95

**\$87** COMPLETE

Slide controls for volume, balance and tone. Full size BSR automatic changer, 2 large horn speakers. Switch for CD4 sound.

**Famous Name  
Fragrances  
For Mother's Day**



Choose from intimate, Chanel, Chantilly, Charlie, Wind Song, Jean Nate, Green Apple, Max Factor, Helena Rubenstein, Arpege, Lanvin, Revlon, many others.



**Caldor  
Cosmetic Puffs**  
Our Reg. 59c  
**39c**  
Package of 260.



**Wet Ones Moist  
Towelettes**  
Our Reg. 99c  
**73c**  
Package of 70.



**Colgate  
Toothpaste**  
Our Reg. 1.35  
**84c**  
For bright, white teeth! 9 oz.



**Cepacol  
Mouthwash**  
Our Reg. 1.69  
**89c** 32 oz.  
Keeps your mouth feeling fresh.



**Paperback  
New York Times  
Book of House Plants**

**3.66**

Publisher's List 5.95

Joan Lee Faust, garden editor of the New York Times, guides beginners and advanced "green thumbs". A most rewarding, exciting hobby.



**Personna Double  
Edged Blades**  
Our Reg. 49c  
**27c**  
Packages of 5 blades.



**Royal Herbal  
Essence Shampoo**  
Our Reg. 69c  
**43c**  
Leaves hair soft, silky. 16 oz.



**Just Wonderful  
Hair Spray**  
Our Reg. 94c  
**59c**  
Use regular or hard to hold, 13 oz.



**Old Spice  
Shave Cream**  
Our Reg. 1.16  
**77c**  
11 oz. all types.



**Bufferin  
for Headaches**  
Our Reg. 1.25  
**97c**  
Bottle of 100 tablets.



**Dial Very Dry  
Antiperspirant**  
Our Reg. 2.19  
**99c**  
Regular or unscented, 12 oz.

**Ready to Assemble  
Ready to Paint  
FURNITURE**

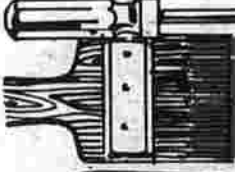

**3 Shelf Book-  
case**  
24"x36"x9" ..... **12.87** Reg. 16.87



**Night Stand**  
14"x26"x11" ..... **12.87** Reg. 16.87



**3 Shelf Bookcase**  
30"x36"x9" ..... **14.87** Reg. 19.87



**Storage Chest**  
26"x20"x15" ..... **16.87** Reg. 22.87



**White Pine  
Rolltop Desk** ..... **29.99** Reg. 45.99



**5 Drawer Desk  
(with Hardware)** ..... **32.88** Reg. 39.99



**3 Drawer Chest**  
24"x28"x14 1/2" ..... **24.88** Reg. 29.99



**4 Drawer Chest**  
24"x36"x14 1/2" ..... **31.40** Reg. 39.99  
Not in Riverside, Bedford, Fairfield

**Assembled Ready to Paint  
CHAIRS**



**Selected Hardwood  
Contour Chair** ..... **7.84** Reg. 9.94



**Hardwood Ladder  
Back Chair** ..... **11.77** Reg. 15.94  
Not in Riverside, Bedford, Fairfield.

**Popular, Beautiful  
WICKER**



**Handy 3 Tier Shelf**  
Our Reg. 13.88  
**9.76**  
Attractive storage for cosmetics, display space for novelties.



**Nymph Chair or  
24" Nymph Table**  
**YOUR CHOICE 19.70** Each Reg. to 27.95  
Two chairs and a table make an attractive grouping.

**Cosco  
Serving Cart**  
Our Reg. 21.95  
**15.77** 31" high, 3 shelves size 16 1/2"x23"; heavy chromed frame.



**WEST BEND "Tuf White"  
Cookware Set**  
Our Reg. 29.99  
**19.99**  
1 and 2 quart covered saucepans, 5 qt. Dutch oven, 10" open skillet. 5 year guarantee.



**7 Jar Canner  
with Rack**  
Our Reg. 8.99  
**5.88** 20 quart size holds 7 qt. or 7 pint jars at once. Polished aluminum for even heat.



**4 Qt. Presto  
Pressure Cooker**  
Our Reg. 15.99  
**12.99**  
Cast aluminum; exclusive pressure regulator.  
**6 Quart Presto Pressure Cooker**  
For big family meals! ..... Reg. 18.99 **15.99**

SAT. APRIL 26  
STAMFORD ADVOCATE  
PATENT TRADER  
NORWALK HOUR  
NORTH HAMPDEN GAZETTE  
NEW LONDON DAY  
SUN. APRIL 27  
POUGHKEEPSIE JOURNAL

NEW YORK TIMES  
LOWELL SUN  
WATERBURY REPUBLICAN  
NEW YORK SUNDAY NEWS  
BRIDGEPORT SUN POST  
DANBURY NEWS TIMES  
HARTFORD COURANT  
NORWICH BULLETIN  
KINGSTON FREEMAN

ADVERTISING SUPPLEMENT TO THE FOLLOWING NEWSPAPERS:  
NEW HAVEN REGISTER  
SOUTH MIDDLESEX NEWS  
MON. APRIL 28  
GREENWICH TIME  
PEEKSKILL STAR  
LYNN ITEM  
LAWRENCE EAGLE

WALTHAM NEWS  
ROCKLAND JOURNAL  
WHITE PLAINS REPORTER  
WED. APRIL 30  
NEW BRITAIN HERALD  
ANSONIA SENTINEL  
BRISTOL PRESS  
FAIRPRESS

MANCHESTER HERALD  
AMHERST RECORD  
NEW CANAAN ADVERTISER  
STEP SAVER  
TORRINGTON REGISTER  
MERIDEN RECORD JOURNAL  
MIDDLETOWN PRESS

MINUTEMEN PUBLICATIONS  
MILDEN NEWS  
MELROSE NEWS  
WARFIELD ITEM  
MELFORD MERCURY  
HAVERHILL GAZETTE  
OSSING REGISTER  
WILLIAMSBURG CHRONICLE  
GOLD MINE